

**ASSESSMENT OF THE IMPACTS OF CHEMICAL DE-BUSHING ON
HERBACEOUS VEGETATION AND GROUND- DWELLING INVERTEBRATE
COMMUNITIES AT NEUDAMM FARM**

A MINI THESIS SUBMITTED IN PARTIAL FULFILMENT
OF THE REQUIREMENTS FOR THE DEGREE OF
MASTER OF SCIENCE IN RANGELAND RESOURCES MANAGEMENT
(ANIMAL SCIENCE)

OF
THE UNIVERSITY OF NAMIBIA

BY

Justine N. Zeriua

(200120263)

APRIL 2020

MAIN SUPERVISOR: Prof. Isaac Mapaure (University of Namibia)

CO-SUPERVISOR: Dr. Simon Angombe (University of Namibia)

ABSTRACT

This study aimed at assessing the impacts of chemical de-bushing on herbaceous plants and ground-dwelling invertebrates at Neudamm farm. Three experimental sites (camp's 5, 6 and 7) treated in 2015, 2016 and 2017 respectively with a general purpose arboricide were selected alongside one (camp 4) untreated site. Pitfall traps were placed under 15 *Senegalia mellifera* trees which were strategically selected in each site. Three quadrates, two placed contiguous under the canopy and one outside the canopy of fifteen *Senegalia mellifera* trees were used to identify and record the herbaceous plants. The herbaceous species diversity was higher in the control camp than in the other camps ($H=29.285$, $d.f=3$, $p < 0.000$), while the ground-dwelling invertebrate diversity ($H=2.497$, $d.f=3$, $p < 0.5$) and Family richness ($H=0.285$, $d.f=3$, $p=0.963$) did not differ significantly between the camps. However, species richness was higher in camp 5 (treated in 2016) than in the control camp ($H=13.085$, $d.f=3$, $p < 0.000$). The HCA on binary data separated the herbaceous plant species into 6 clusters and the pitfall traps into 7 clusters indicating the significant changes in herbaceous species and invertebrate family composition due to chemical treatment, among other factors. Grass biomass was higher in camp 5 ($p < 0.001$) and the control camp had the highest ground cover ($H=8.5$ and $p\text{-value}=0.037$). This study has shown that arboricides have significant direct negative effect on herbaceous vegetation and, to a lesser extent, on the ground-dwelling invertebrates.

Key words: herbaceous vegetation, invertebrates, arboricides, bush encroachment, species, composition and biodiversity.

TABLE OF CONTENTS

ABSTRACT	i
LIST OF TABLES	vi
LIST OF FIGURES	vii
LIST OF ABBREVIATIONS AND/ OR ACRONYMS	x
ACKNOWLEDGEMENTS	xi
DEDICATION	xii
DECLARATION	xiii
CHAPTER 1	1
1. Introduction	1
1.1 Background of the study	1
1.2 Statement of the problem	2
1.3 Objectives.....	3
1.3.1 Overall objective	3
1.3.2 Specific objectives	4
1.4 Null Hypotheses	5
1.5 Significance of the study.....	5
CHAPTER 2	6
2. Literature Review.....	6
2.1 Bush encroachment	6

2.2 Causes of bush encroachment	7
2.3 Bush encroachment control methods	7
2.4 Effects of chemicals de- bushing on plant diversity	9
2.5 Effects of chemical de- bushing on invertebrates diversity	11
CHAPTER 3	13
3. Research Methods	13
3.1 Description of the study area.....	13
3.1.1 Location and extent	13
3.1.2 Climate	14
3.1.3 Physical features, geology and soils.....	14
3.1.4 Land use	15
3.2 Research design.....	15
3.3 Sampling procedure	16
3.3.1 Soil and ground-dwelling invertebrates	16
3.3.2 Inventory of herbaceous plants and measurement of biomass.....	17
3.4 Data analysis	18
CHAPTER 4	20
4. Results	20
4.1 Herbaceous Plants	20
4.1.1 Herbaceous species diversity and richness	20

4.1.2 Herbaceous species composition.....	22
4.1.3 Grass biomass and cover.....	26
4.1.4 Rangeland condition.....	28
4.1.5 Gradients in herbaceous species data.....	30
4.2 Ground-dwelling invertebrates.....	32
4.2.1 Relative abundance of invertebrates.....	32
4.2.2 Invertebrate diversity and richness.....	34
4.2.3 Invertebrate species composition.....	35
4.2.4 Gradients in invertebrates data.....	38
CHAPTER 5.....	40
5. Discussion.....	40
5.1 Herbaceous diversity, richness and composition.....	40
5.2 Herbaceous biomass and cover.....	43
5.3 Rangeland condition and grazing values of grasses.....	44
5.4 Invertebrate species abundance.....	46
5.5 Invertebrate species diversity, richness and composition.....	46
CHAPTER 6.....	49
6. CONCLUSIONS AND RECOMMENDATIONS.....	49
6.1 Conclusions.....	49
6.2 Recommendations.....	52

References	53
Appendices	62
Appendix 1:	62

LIST OF TABLES

Table 1: Relative abundance of the invertebrates collected from each site of the experiment and their proportions in each site.....32

LIST OF FIGURES

Figure 1: The location of highland savanna (Khomas Hochland Plateau) in Namibia. (Adopted: from Atlas Namibia by Mendelsohn, et al, 2009).....	13
Figure 2: Neudamm Farm No. 63 Map (Extracted: from Neudamm farm archives).....	14
Figure 3: Schematic design for the randomly selected trees, three (3) quadrates (QRT) under each of the fifteen (15) trees in each experimental camp for herbaceous biota and fifteen (15) pitfall traps (PFT) under fifteen (15) trees sampled in each camp for the invertebrates. C4= Camp 4.....	16
Figure 4: Simple boxplot for the Species diversity indices of herbaceous plants in the four Camps. Camp 4 (control), Camp 5 chemically treated in 2016, Camp 6 treated in 2017, and Camp 7 treated in 2015.....	21
Figure 5: Mean species richness of the four experimental camps. Camp 4 (control), Camp 5 chemically treated in 2016, Camp 6 treated in 2017, and Camp 7 treated in 2015.....	22
Figure 6: Hierarchical Cluster Analysis (HCA) based on Bray-Curtis similarity matrix of herbaceous plants species data from the four experimental sites; C4P1 (Camp 4 Plot 1), ...C5P1 (Camp 5 Plot 1),...C6P1 (Camp 6 Plot 1),...C7P1 (Camp 7 Plot 1). G1-G6... represents the group of plots forming a cluster. Camp4 (control) was not treated, Camp5 was chemically treated in 2016, Camp6 was chemically treated in 2017 and Camp7 was chemically treated in 2015	23

- Figure 7:** Mean grass biomass among of the four experimental camps:C4 (control) = Camp 4 the Control, C5 (2016) = Camp 5 chemically treated in 2016, C6 (2017) = Camp 6 treated in 2017, and C7 (2015) = Camp 7 treated in 2015.....26
- Figure 8:** Median percentage cover of herbaceous plants of the four experimental camps. Camp4 (control), Camp 5 chemically treated in 2016, Camp 6 treated in 2017, and Camp 7 treated in 201527
- Figure 9:** The functional groups of the different grass species found in the camps. C4 (control) = Camp 4 untreated, C5 (2016) = camp 5 chemically treated in 2016, C6 (2017) =camp 6 treated in 2017, and C7 (2015) = camp 7 treated in 201528
- Figure 10:** The grazing values of the different species found in the study camps/sites within the camps and across the camps using chi- square29
- Figure 11:** Detrended Correspondence Analysis (DCA) ordination diagram of the herbaceous species recorded from the four experimental sites (C4, C5, C6 and C7). The C4P1stands for (Camp 4 Plot 1), ...C5P1 (Camp 5 Plot 1),...C6P1 (Camp 6 Plot 1),....C7P1 (Camp 7 Plot 1)..... 31
- Figure 12:** Total abundance of ground- dwelling invertebrates per Family among the four camps. C4 = camp 4, C5 = camp 5, C6 = camp 6 and C7 = camp 7.....33
- Figure 13:** Median ground-dwelling invertebrate diversity among the four camps. Camp 4 (control), camp 5 chemically treated in 2016, camp 6 treated in 2017, and camp 7 treated in 2015.....34

Figure 14: Median ground-dwelling invertebrate richness among the four camps. Camp 4 (control), Camp 5 chemically treated in 2016, Camp 6 treated in 2017, and Camp 7 treated in 2015.....35

Figure 15: Hierarchical Cluster Analysis (HCA) dendrogram showing differences in invertebrate family composition among the experimental sites, C4T1P1 (Camp 4 Pitfall trap 1), ...C5T1P1 (Camp 5 Pitfall trap 1),...C6T1P1 (Camp 6 Pitfall trap 1),....C7T1P1 (Camp 7 Pitfall trap 1). The G1- G7 ... represents the group of traps forming clusters. Camp4 (control) was not treated, Camp5 was chemically treated in 2016, Camp6was chemically treated in2017 and Camp7was chemically treated in2015.....37

Figure 16: Detrended Correspondence Analysis (DCA) ordination diagram of the invertebrate families recorded from the pitfall traps that were under the fifteen sampled trees in the four experimental sites (Camp 4, Camp 5, Camp 6 and Camp 7). The C4T1P1 stands for (Camp 4 Pitfall trap 1) ...C5T1P1 (Camp 5 Pitfall trap 1),..C6T1P1 (Camp 6 Pitfall trap 1), ..C7T1P1 (Camp 7 Pitfall trap 1).....39

LIST OF ABBREVIATIONS AND/ OR ACRONYMS

DAS	De- bushing Advisory Services
DCA	Detrended Correspondence Analysis
GIZ	Deutsche GesellschaftFürInternationaleZusammenarbeit (GIZ) GmbH
HCA	Hierarchical Cluster Analysis
LSU	Large Stock Unit
MAWF	Ministry of Agriculture, Water and Forestry
MDS	Multi- Dimensional Scaling
MET	Ministry of Environment and Tourism
PFT	Pitfall Trap
QRT	Quadrat
RR	Risk Ratio
SABS	South African Bureau of Standards
SPSS	Statistical Packages for Social Sciences

ACKNOWLEDGEMENTS

First and foremost I would like to give thanks to the Almighty for giving me the strength to pull through this journey, it was not an easy journey but with Him everything is possible. Secondly, I am giving thanks to my supervisors; Prof. Mapaire and Dr. Angombe for helping me throughout my thesis without being tired, your time and effort are appreciated. I will be indebted if I do not mention the help I got from Dr. Eugene Marais of Gobabeb Research and Training Centre in the identification of invertebrates as well as the entire staff of Gobabeb Research and Training Centre for their assistance. The help of Mr. Benson Muramba and Mr. Kaapehi of the Natural History Museum of Namibia under the Ministry of Education is also appreciated. I would like to give thanks to the Farm Section of the University of Namibia at Neudamm Campus for their assistance in giving me access to the camps, transport and giving me directions. I would also like to thank my right hand field assistants; Rinovita Kamuhanga and Lowrens Katjavivi. And lastly I would like to acknowledge the role of the Ministry of Agriculture, Water and Forestry; Division: Product Development, Training and Quality assurance (PDTQA) for the financial assistance throughout my studies.

DEDICATION

I dedicate this thesis to my children, Ivethé Vejaraara Mungendje and Ndjipua Tjihoreko. They are the greatest inspiration in my life and make me wake up and work harder every day. Their existence gives me the reason to wake up every day no matter how hard it seems. I wish them a great journey in their education and I hope they learn from the best.

DECLARATION

I, Justine Ngatuuane Zeriua, hereby declare that this study is my own work and is a true reflection of my research, and that this work, or any part thereof has not been submitted for a degree at any other institution.

No part of this thesis/dissertation may be reproduced, stored in any retrieval system, or transmitted in any form, or by any means (e.g. electronic, mechanical, photocopying, recording or otherwise) without the prior permission of the author, or The University of Namibia in that behalf.

I, Justine Ngatuuane Zeriua, grant The University of Namibia the right to reproduce this thesis in whole or in part, in any manner or format, which The University of Namibia may deem fit.

.....

Date

Justine Ngatuuane Zeriua

CHAPTER 1

1. Introduction

1.1 Background of the study

Bush encroachment is the invasion of woody species causing an imbalance in the grass: bush ratio leading to a decline in the carrying capacity and a loss/decrease in biodiversity (Birch et al., 2016 and Rothauge, 2017). It has become a major degradation problem in Namibia. Bush encroachment on rangelands in Namibia evidently caused huge losses economically and ecologically as it affects about 45 million hectares of land (Shekuza, 2015; GIZ, 2017; Honsbein and Lindeque, 2017). Birch et al., (2016) highlights the key ecosystem services that are negatively affected by the rapid increase of the woody species in Namibia as; the livestock production, ground water recharge, tourism and biodiversity. Amongst others the most common encroacher tree/bush species in Namibia are *Dichrostachys cinerea*, *Senegalia mellifera*, *Colophospermum mopane* and *Terminalia sericea* (Rothauge, 2017). The combination of thorniness and low digestibility of these trees/bushes reduces their accessibility and nutritional value to livestock (Bond and Midgley, 2012).

Bush encroachment is caused by many factors such as “continuous grazing, under stocking, fires, increased atmospheric carbon dioxide and the depletion of soil minerals” (DAS, 2016; Joubert and Zimmermann, 2017), the amount and frequency of rainfall also determines the dominance of bushes (Devine et al., 2017). However these factors that causes bush encroachment are poorly understood (Bond and Midgley, 2012). There is

need to evaluate bush control techniques to help combat the negative effects of bush encroachment.

There are various ways of controlling bush encroachment and they differ with regard to their efficiency, effectiveness and environmental stability (DAS, 2016). These methods are divided into mechanical, chemical, fire and biological methods. Mechanical methods include chopping, slashing, ring barking and felling of trees (Bush Encroachment and Forestry - South Africa, 2010). Biological methods entail the use of natural pests or browser pressure to prevent bush encroachment, while chemical control entails the application of arboricides either to stems, foliage or to the soil to kill woody plants (Askari, 2010; DAS, 2017). According to Joubert and Zimmermann (2017) and Rothauge (2017) soil based arboricides are much more rapid than the stem and foliage applications. “Soil-applied arboricides used most often in Namibia contain the active ingredients Bromacil or Tebuthiuron” (Rothauge, 2017).

Bromacil and Tebuthiuron are broad-spectrum arboricides used for bush control on non-crop areas, rangelands, rights-of-way, and industrial sites (Acero, 2017). They are effective on woody and herbaceous plants in grasslands and sugar cane. However, the impact of these arboricides on the ground-dwelling invertebrates and the non-targeted herbaceous vegetation are poorly understood and documented hence the importance of the study.

1.2 Statement of the problem

All the efforts of bush clearance are aimed at improving rangeland productivity and to evaluate the effectiveness of the methods used. However, the bush control methods may

have unintended negative effects on the soil biota and herbaceous plant species in a rangeland as some of the soil organisms play important roles in the structure and functioning of the ecosystems and rangeland productivity. Mechanical/manual methods such as the bulldozers are destructive and also expensive while felling with the aid of chain saws, machetes and axes is a cheaper and less destructive bush clearance though labor intensive method (Kahumba, 2010). As fire eradicates unwanted species and breaks seed dominance (Snyman, 2015), it also removes with it the untargeted species. Fire can therefore, also affect the ground-dwelling invertebrates. The use of browsers and micro organisms such as fungi also gained momentum, though they are more used in prevention than treatment of the bush encroachment problem (DAS, 2017). Many studies concluded on the effectiveness of the chemical control to the targeted species such as the unwanted bushes/shrubs (Kahumba, 2010; Snyman, 2015; SAIEA, 2016; Rothauge, 2017b), while the effect of the chemical to the untargeted species (Herbaceous and invertebrates) is not well studied and their effect are therefore unknown. The main objectives of this study was to evaluate the impact of the chemicals/arboricides on the herbaceous species and ground-dwelling invertebrates as they are untargeted yet important species in the functioning of the rangeland ecosystem.

1.3 Objectives

1.3.1 Overall objective

The main objective of this study was to determine the impact of chemical de-bushing on the diversity of herbaceous vegetation and ground-dwelling invertebrates of bush cleared rangelands at Neudamm Farm.

1.3.2 Specific objectives

The specific objectives of this study were to:

- (a) To investigate the impact of chemicals (Bromacil and Tebuthiuron) on herbaceous vegetation by evaluating the herbaceous vegetation species gradients, composition, richness and diversity as well as their impact on rangeland conditions by evaluating the grazing values and functional groups in the camps.
- (b) To assess the impact of chemicals (Bromacil and Tebuthiuron) on total grass biomass production.
- (c) To investigate the impact of chemicals (Bromacil and Tebuthiuron) on ground-dwelling invertebrates by evaluating the invertebrate's family composition, richness and diversity; and the invertebrate's family gradients.

1.4 Null Hypotheses

The study sought to address the following null hypotheses:

- (a) De- bushing rangelands with chemicals does not have a significant effect on herbaceous vegetation species gradients, composition, richness, diversity and Rangeland conditions
- (b) De- bushing rangelands with chemicals does not have a significant effect on total grass biomass production.
- (c) De- bushing rangelands with chemicals does not have a significant effect on the composition, richness and diversity and family gradients of ground- dwelling invertebrates.

1.5 Significance of the study

The effectiveness of bush clearing using chemicals has been shown to be effective although with cost implications (DAS, 2017). However, the ecological impacts of such chemicals on the environment are poorly understood and there is little literature available on the effects of arboricides on biodiversity. It is important to establish the effect of bush clearing chemicals on the various ecosystem components such as diversity and composition. The proposed study will provide objective data and information on the effects that the chemicals might have on diversity, richness and composition of the herbaceous vegetation and the ground- dwelling invertebrates in the Hochland rangeland ecosystems.

CHAPTER 2

2. Literature Review

2.1 Bush encroachment

Bush encroachment has been recognized in southern Africa since the late nineteenth century (O'Connor et al., 2014). Bush encroachment is characterized by the suppression of palatable grasses and herbs by encroaching woody species, often unpalatable to domestic livestock, reducing the carrying capacity for livestock (Muluaem and Shimles, 2018). Lesoli et al., (2013) also argue that high bush density in rangelands reduces land accessibility by livestock which subsequently affect negatively the utilization of rangelands. Joubert and Zimmerman (2017) describe bush encroachment as a symptom of rangeland degradation that is caused by factors such as continuous grazing, under stocking and fires that burn early in the dry season, all of which reduce the vigor of perennial grasses. Bush encroachment in the Namibian savannas is seen to be part of the process of desertification and has resulted in a great loss of land productivity (DAS, 2017) and also causing the carrying capacity to decline from 1 LSU per 10 ha to 1 LSU per 20 or 30 ha. Lesoli et al., (2013) reviewed the negative ecological impacts of the fast invasion of black wattle (*Acacia mearnsii*) in South African rangeland ecosystems to include, amongst others, the loss of biodiversity, increase in fire hazard, and increases in soil erosion. It is however, thus attaining economic importance in many parts of South Africa.

2.2 Causes of bush encroachment

The attempt to elaborate the causes of bush encroachment are based upon the background of two important models: Walter's Two-layer Model for tree-grass co-existence and the State-and-Transition Model (Shimles and Muluaem, 2018), however, none of these supposed mechanisms of bush encroachment has been credibly verified under field conditions. O'Connor et al., (2014) have proposed several drivers of bush encroachment which interact and change over time, for example the suppression of fires, and reduction in browsing herbivores. Back fire or a cool head fire can promote bush encroachment by removing the grass layer (and thus competition) without damaging any of the woody plants (Lemus and Gordon, 2018). Other causes of bush encroachment as documented by Kgosikoma and Mogotsi (2013) are rainfall availability and soil properties; where increased soil moisture availability when there is limited competition from grasses allows woody plant seedlings to survive and grow into bush thickets. Woody cover is negatively correlated with soil clay content and nitrogen (Sive, 2016). In the Kalahari sands of Botswana bush encroachment is likely to occur in sandy soils with low clay content (Kgosikoma et al., 2012b).

2.3 Bush encroachment control methods

Bush control methods are aimed at shifting the rangeland vegetation from dominance by woody vegetation to herbaceous vegetation (Lesoli et al., 2013) for livestock sustenance.

The use of fire to control bush encroachment has been a traditional method for some years. Fire eradicates unwanted species and reduces moribund grass as it consequently triggers germination by breaking seed dormancy through heat and smoke (Snyman, 2015). It is an effective bush control method but the process is very labor-intensive and

relatively slow (Christian, 2010). However, some of the soil seed banks can be negatively affected by fire cues (Snyman, 2015). Gandiwa (2011) reported that fire regimes have major impacts on the fire sensitive species and that conservative fire management constitutes a major challenge for extensive areas of semi-arid lands in savanna ecosystems. Use of fire to control invasive woody plants is justified by the fact that when woody plants are burned they do not recover or they take a longer time to recover (Lemus et al., 2018). This gives the herbaceous species time to grow with minimal or no competition. A minimum of 1,500 to 2,000 kg grass per hectare is needed to ensure an effective burn (Christian, 2010), however according to Kgosikoma and Mogotsi (2013) the sustainable use of fire as a management tool requires knowledge of future climatic conditions and the ability to minimize its negative impact.

Manual or mechanical bush control can be highly selective and ecologically sustainable but is also one of the slowest bush control methods, and without coupled value addition of the harvested biomass, it can also be a relatively costly exercise (DAS, 2017), and aftercare should be employed to reduce or prevent re- growth. Bush-clearing by means of bulldozers for rangeland reclamation purposes is not recommended because they are unselective (Christian, 2010). Thus hand clearing targeting unwanted plants and creating a competitive space for desired plants is recommended (DAS, 2017). Bulldozers are, however, maneuverable and can be steered around large non-target woody plants by a skilled and alert operator (Rothauge, 2017).

Biological bush control refers to when natural factors such as fungi, browsing pressure and fire is used to control bush. The use of browsing animals such as game species, goats and sheep to clear bush is successful at a very high stocking rate (Christian, 2010)

and is best used as an aftercare method, once the primary bush control activity has taken place (DAS, 2017 and Rothauge, 2017).

Chemical bush control methods entail the application of chemicals known as arboricides which contain active ingredients that kill woody plants (DAS, 2017). There are two broad groups of arboricides used in rangelands; the soil surface application (selective) and the aerial based application (non – selective) group. The use of selective arboricides is aimed at reducing the competitive ability of invasive species and killing them and species that are not affected by this arboricides gain an advantage (Lesoli et al., 2013). According to Rothauge (2014) most rangeland experts in Namibia favor the selective ground – based application programme. The soil based arboricides are based on Tebuthiuron, Ethidimuron or Bromacil as their active ingredient (Lesoli et al., 2013). Bromacil and Tebuthiuron are broad spectrum arboricides with active ingredients contents of 800 g/l and 527 g/l, respectively, as attested by SABS (Honsbein, 2012). It was concluded in a survey conducted in 2014 that amongst Namibia’s commercial farmers two-thirds of those who control encroacher bush do so by chemical means, using arboricides (Rothauge, 2017).

2.4 Effects of chemicals de- bushing on plant diversity

Arboricides vary in their chemical properties, mode of action and differ in their modes of applications (Lesoli et al., 2013 and Christian, 2010). The chemicals used for bush clearing also inhibit respiration and photosynthesis as well as the formation of nucleic acids, and the chemicals have a residual effect of up to four years (Christian, 2010). There is an increasing concern about the use of Bromacil for the control of invasive species on South African rangelands due to its effect on target grasses, broad leaved

plants and other biotic components of the rangeland ecosystem (Lesoli et al., 2013). Also there are known incidents from Namibian farms where soil-applied arboricides kill non-target trees decades after the last application (Rothauge, 2017a).

Although Honsbein et al., (2012) report that at lower concentrations of Tebuthiuron, woody bush species are much more sensitive than grasses or forbs the exact impact of the arboricide on the grasses and forbs are not studied yet. Ethidimuron, which is the active ingredient in the arboricide Ustilan, was also used in the past but is not in use in Namibia anymore (Christian, 2010).

Wood decomposition rates have been observed to be much slower after arboricide application and the accumulation of arboricides may cause unwanted ecosystem impacts (Joubert and Zimmermann, 2017). The skeletons of bushes and trees remain standing for an unusually long period of time as arboricides kill off the micro-organisms needed for decay and decomposition of wood (Rothauge, 2017b). However, Haussmann et al., (2015) reported that the removal of *Senegalia mellifera* with chemicals promoted the establishment of undesired woody species. Arboricides do not kill bush seeds and these germinate rapidly when rainfall is favorable and establish within 2-3 years, potentially re-colonizing the landscape soon after chemical bush control (Rothauge, 2017a).

2.5 Effects of chemical de- bushing on invertebrates diversity

Namibia has a high level of endemism in plants, invertebrates, reptiles and frogs (MET, 2013). Many small organisms, such as beetles, millipede, centipedes and flies, play a vital role in the production and maintenance of healthy soils by returning nutrients to the soil, and therefore are key elements in the development of sustainable agriculture and forestry.

Anthropogenic disturbances in ecosystems can dynamically impact populations of ground- dwelling invertebrates that regulate key ecosystem processes (Perry and Herms, 2019). The study conducted by Hering et al., (2018) concluded that the majority of beetle species were only active on sites with relatively intact grass and forbs layers. It further concluded that such reduction of the grass and forbs will alter and reduce crucial ecosystem functions such as decomposition and nutrient cycling. According to Ding et al., (2019), the removal of woody species can promote grass and total ground storey biomass when physical and chemical methods were employed, however, the response declines with time since treatments. Other factors such as fire affect some environmental variables upon which the invertebrates depends (Garcia- Dominguez, et al., 2010). The study concluded that fire did not have important impact on the structural parameters of the ground- dwelling invertebrate's communities, but the species composition changed. In another study by Haddad, et al., (2015) on the effect of fire on spider abundance, there was a considerable initial post- fire decline in spider abundance. While it is known that pesticides and herbicides can contaminate soil, water, turf and the vegetation they can also kill insects and weeds, other organisms including birds, fish, beneficial insects and non- targeted plants (Aktar et al., 2009). However Kahumba, (2010) concludes in

his findings that the general use of herbicides is not likely to harm the environment when used according to label directions, even though exact effects of Bromacil and Tebuthiuron on invertebrates are to be quantified and documented.

CHAPTER 3

3. Research Methods

3.1 Description of the study area

3.1.1 Location and extent

The study was conducted at Neudamm farm situated about 30 kilometers east of Windhoek on the B6 road to Hosea Kutako International Airport in the highland savannas of Namibia in Khomas Region. Neudamm farm measures about 10 137 ha and it is located at latitude $22^{\circ} 27' 02''$ and longitude $17^{\circ} 21' 38''$ and at an altitude of 1856 m above sea level.

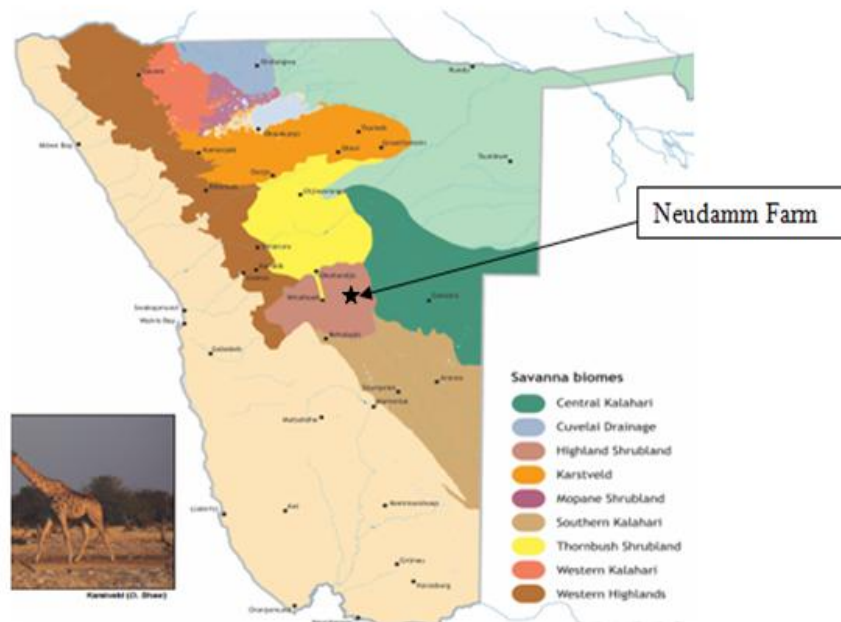

Figure 1: The location of highland savanna (Khomas Hochland Plateau) in Namibia.

(Adopted: from Atlas Namibia by Mendelsohn, et al., 2009).

Neudamm farm is divided onto Blocks (A to J) which are further divided into camps as shown in the map below. The extent of the study area is about 25 ha per camp.



Figure 2: Neudamm Farm No. 63 Map. Extracted: from Neudamm farm archives, 2017.

3.1.2 Climate

The annual rainfall around Neudamm farm is $409\text{mm} \pm 196\text{ mm}$ with much of the rain falling during the summer months (January- March) (Kandiwa et al., 2017). The average maximum temperature in summer is about 29°C , while in winter the average minimum temperature is approximately 3°C but -9°C is recorded regularly and frost occurs about 20 nights per year (Mendelsohn et al., 2009).

3.1.3 Physical features, geology and soils

The Highland Savanna occurs at altitudes of 1350m to 2200m above sea level and with some extremely steep slopes of more than 30° (van der Merwe, 2011). According to Coetzee (2009) the landform in the Highland savanna has high gradient mountains

dominated with very shallow rooting depth and a highly broken and undulated terrain as is evident in the Neudamm landscapes. The savanna is dominated by mountain soils, Lithic Leptosols and Eutric Regosols soil types, overlaying base material of sandstone and metamorphic schists (van der Merwe, 2011).

3.1.4 Land use

Highland savanna is characterized by shrubs and low trees, mainly *Vachellia* and *Senegalia* species. The undisturbed rangelands consist of climax grasses such as *Schmidtia pappophoroides*, *Antheophora pubescens*, and *Brachiaria nigropedata* and many other palatable grass species (van Oudtshoorn, 2012). The land is mainly used for grazing purposes. The Block used for the study currently hosts small stock, but the whole farm is grazed by cattle, goats, sheep and wildlife. The Block that was selected had camps which were chemically de-bushed and a camp not de-bushed which was used as control. The camps were selected in the same block to minimize potential differences in physical features, geology and soils which could otherwise have an influence on the results obtained. There is a water point in the corner of Block D camp 6.

3.2 Research design

A stratified random sampling approach with systematic sampling was used. Three chemically treated camps (5, 6 and 7) and one untreated camp (4) was selected in block D. Camp 5 and 6 were treated with Bromacil in 2016 and 2017, respectively, while Camp 7 was treated with Tebuthiuron in 2015. In each camp fifteen (15) *Senegalia mellifera* trees only were randomly selected and with a distance of at least 5 meters apart. For each *Senegalia mellifera* tree three vegetation inventory quadrates each

measuring 1m x 1m were demarcated. A separate fifteen *Senegalia mellifera* trees in each of the four camps were randomly selected. A pitfall trap was dug and fitted under each selected tree, giving a total of 60 pitfall traps for the experiment (Sherley & Stringer, 2016).

Design layout (Herbaceous Vegetation), same design for each camp (i.e. Camp 4, 5, 6, 7)

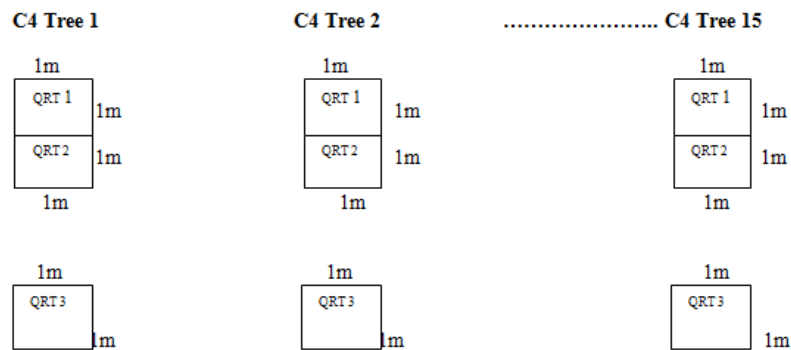

Design layout (Invertebrates), same design for each camp (i.e. Camp 4, 5, 6, 7)

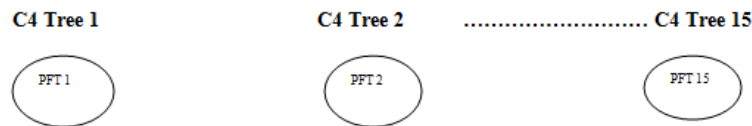

Figure 3: Schematic design for the randomly selected trees, three (3) quadrates (QRT) under each of the fifteen (15) trees in each experimental camp for herbaceous biota and fifteen (15) pitfall traps (PFT) under fifteen (15) trees sampled in each camp for the invertebrates. C4= Camp 4.

3.3 Sampling procedure

3.3.1 Soil and ground-dwelling invertebrates

Wet pitfall traps were used to sample ground-dwelling invertebrates (Sherley and Stringer, 2016). Plastic pitfall traps that were 11 cm in top diameter and 8cm in depth

were strategically dug into the ground under the targeted *Senegalia mellifera* trees. The pitfall traps were placed under 15 trees (1 trap per tree) in each of the camps used in the study. The pitfall traps were half-filled with soapy water to break the surface tension of the water so that the invertebrates did not escape the traps. These traps were allocated numbers from one to fifteen in each camp, such that pitfall trap1 in camp5 was labeled C5: PFT 1. The traps were set in the morning and the samples were collected the next morning (trapped for 24 hours).

The trap contents were transferred into labeled plastic jars with lids and transported to the laboratory for preservation. The soapy water was drained out and 70 % alcohol was added to the sample jars. The preserved samples were then transported to the natural history museum where they were identified to Order and Family levels. After identification all the invertebrates were counted in their respective Orders or Families to later determine family richness and diversity per trap.

3.3.2 Inventory of herbaceous plants and measurement of biomass

Three quadrates were placed under each tree where herbaceous inventories were done. Two quadrates were contiguous under the canopy and one outside the canopy. All herbaceous plants (grasses and forbs) in each quadrate were identified and recorded. The identifications were done using appropriate field guides. All the grasses in the second and third quadrates were clipped at their bases with a pair of secateurs. The two samples were placed in separate paper bags for the measurement of biomass. Clipped grass samples were dried in an oven at 55°C for 48hr (Redjadj et al., 2012) and weighed to determine the dry mass. The covers from all the quadrates were visually assessed (Bunning et al., 2011) and recorded.

3.4 Data analysis

The Family binary data were used to analyze the composition of the ground- dwelling invertebrates using Hierarchical Cluster Analysis (HCA) performed with the Primer 5.2.0 statistical package. Each experimental site consisted of fifteen pitfall traps.

To compare the diversity of the ground dwelling invertebrates and of plant species among the camps the Diversity Index (H') was calculated on the Shannon Wiener Diversity Index using the Primer 5.2.0 statistical package as follows:

$$\text{Shannon index of diversity: } H' = -\sum p_i \ln p_i$$

Where: p_i is the proportion of individuals found in the i^{th} species and \ln is the natural logarithm.

Invertebrate and plant species diversity were compared using the Kruskal Wallis test and a pair wise comparison was run to separate means of the camps. To compare the herbaceous species composition a Hierarchical Cluster Analysis (HCA) was used. Species binary data were used in the analysis, and the average linkage cluster statistic was used. To improve the visualization of the HCA dendrogram the three quadrates under each tree represented one plot (15 plots in each experimental camp).

The plant species richness data were tested for normality using the Shapiro-Wilk test and the data were not normally distributed. A Kruskal Wallis test was used to compare differences in herbaceous richness among camps and a pair wise comparison was used to separate the mean values.

Herbaceous biomass data were tested for normality with the Shapiro-Wilk test, the data showed a normal distribution after being transformed with \log_{10} . Herbaceous biomass yield was analysed using one way ANOVA. An LSD *post hoc* test was used for mean separation. The Kruskal Wallis test was used to compare herbaceous cover among the four camps.

Grass species were categorized into Decreaser, Increaser II and Increaser III functional groups (van Oudtshoorn, 2012). A Chi-square test of an Association was performed to determine if the above mentioned functional groups were associated more with any of the experimental camps. The grass species were also categorized according to their grazing values (i.e. high, average and low) to determine the rangeland condition, and the proportions of occurrences of these grasses according to their values in the experimental camps were compared with a Chi- square test of association.

A Detrended Correspondence Analysis (DCA) was performed on the vegetation and ground-dwelling invertebrate binary data to examine relationships between species composition and any underlying environmental gradients (i.e. determinants of species compositional differences). DCA is a multivariate analysis that explores data by clustering objects so that similar objects are near each other and dissimilar objects are further from each other. DCA determines the gradient length (Kent, 2012). The DCA gave a two dimensional spatial plot of samples presence and its spatial proximity to other plots.

CHAPTER 4

4. Results

4.1 Herbaceous Plants

4.1.1 Herbaceous species diversity and richness

There was a significant difference in herbaceous species diversity between at least one pair of the experimental camps ($H= 29.285$, $d.f = 3$, $p < 0.001$) (Figure 4). The control camp (Camp 4) had significantly higher median species diversity than the three chemically treated Camps (5, 6 and 7, with $p < 0.001$, 0.01, 0.001, respectively). Camp 6 (treated in 2017) had significantly higher diversity than Camp 7 ($p < 0.05$); (Figure 4).

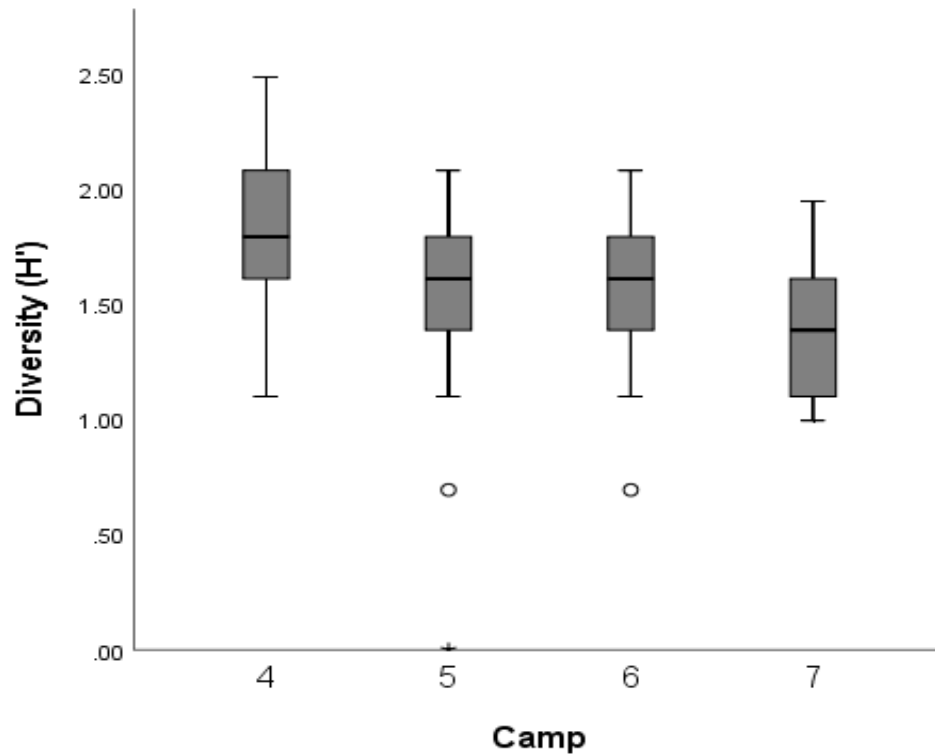

Figure 4: Simple boxplot for the Species diversity indices of herbaceous plants in the four camps. Camp 4 (control), Camp 5 chemically treated in 2016, Camp 6 treated in 2017, and Camp 7 treated in 2015.

Based on the Kruskal Wallis test there was a significant difference in the species richness of at least one pair of camps ($H= 13.085$, $d.f = 3$, $p < 0.01$). There were significantly more species in Camp 5 (treated in 2016) compared to the other three Camps 4, 6, and 7 ($p < 0.01$, and 0.001 , respectively), which in turn were not significantly different (Figure 5). However, Camps 4, 6 and 7 had equal species richness.

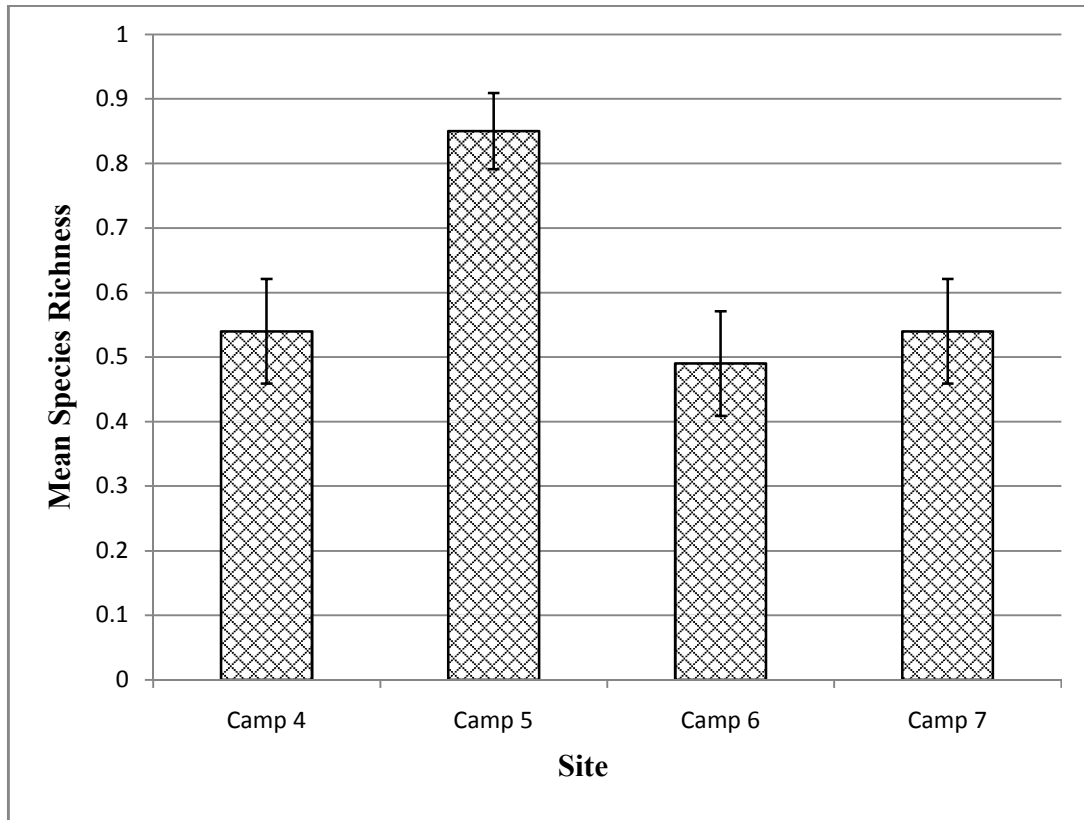

Figure 5: Mean species richness of the four experimental camps. Camp 4 control, Camp 5 chemically treated in 2016, Camp 6 treated in 2017, and Camp 7 treated in 2015. The bars extending beyond the bar graphs denote the Standard Error of Means (SEM).

4.1.2 Herbaceous species composition

The HCA dendrogram in Figure 6 separated the plots from the four camps into 6 clusters.

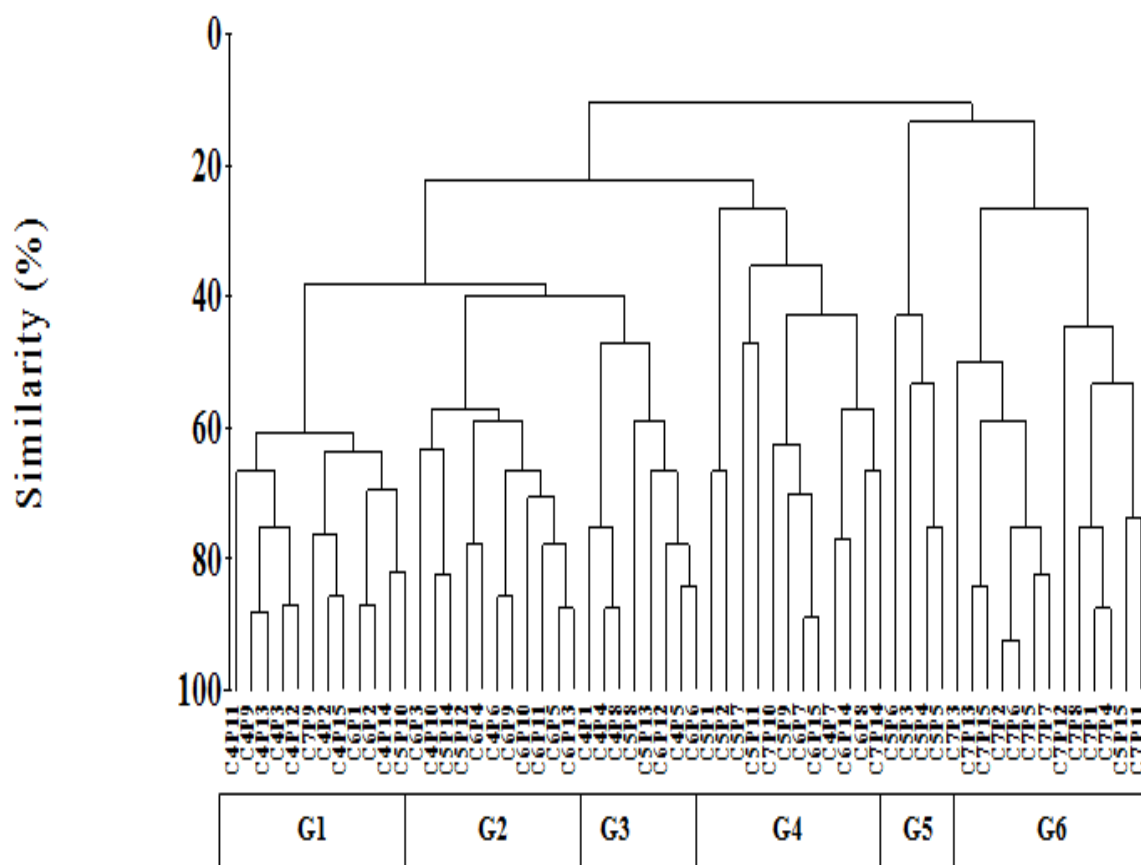

Figure 6: Hierarchical Cluster Analysis (HCA) based on Bray-Curtis similarity matrix of herbaceous plants species data from the four experimental sites; C4P1 (Camp 4 Plot 1), ...C5P1 (Camp 5 Plot 1),...C6P1 (Camp 6 Plot 1),....C7P1 (Camp 7 Plot 1). The G1;-G6 represent the group of plots forming a cluster. Camp4 (control) was not treated, Camp5 was chemically treated in 2016, Camp6 was chemically treated in 2017 and Camp7 was chemically treated in 2015.

The first cluster was composed mostly of plots from the control camp. This cluster was separated from the other clusters at 60 % level of similarity. Cluster 1 was dominated by

Chloris virgata, *Cenchrus ciliaris*, *Melinis repens*, *Eragrostis nindensis*, *Anthehora pubescens*, *Eragrostis rotifer* and *Eragrostis stipitata* grasses, whereas the dominating forbs in this cluster were the *Achyranthes aspera*, *Bidens bipinnata*, *Schkuhria pinnata* and *Pavonia burchelli*.

Cluster 2 was mostly dominated by plots (3, 4, 5, 9, 10, 11 and 13) from Camp 6. This cluster was separated from the others at 58 % level of similarity. From the grass species found in cluster 1, *Chloris virgata* was evidently absent in cluster 2 while the annual *Tagetes minuta* was recorded.

At 50 % level of similarity a third cluster was formed. The most dominating plots in this cluster were plots 1, 4, 5 and 8 of Camp 4. Apart from the grasses found in the previous clusters, cluster 3 had *Schmidtia pappophoroides*.

Cluster 4 was formed at 30 % level of similarity and it was dominated by plots from Camp 5. This cluster had most of the forbs; *Nidorella resedifolia*, *Acanthospermum hispidum* and *Asparagus exuvialis* were unique to this cluster. Other forbs found in this cluster were *Hermannia tomentosa*, *Alternanthera pungens* and *Pollichia campestris*. The rare occurring grass in the study, *Heteropogon contortus* was also found in this cluster.

At 43 % level of similarity cluster 5 was formed and it was composed of plots (3, 4, 5 and 6) from Camp 5. *Sporobolus ioclados*, *Pogonarthria fleckii* were the unique grasses of this cluster. *Talinum caffrum*, *Hibiscus fleckii* and *Evolvulus alsinoides* were the forbs species unique to this cluster. Another species that was not captured in the previous clusters was *Aristida meridionalis*.

Cluster 6 was dominated by almost all the plots of camp 7. *Nelsia quadrangula* and the dwarf *Hibiscus pusillus* were the unique forbs recorded for cluster 6, and the rare occurring grasses *Heteropogon contortus* and *Aristida meridionalis* were also characteristic of this cluster. This cluster separated at 28 % level of similarity from the other clusters.

4.1.3 Grass biomass and cover

Grass biomass means are presented in Figure 7 and there were significant differences in the biomass of the experimental camps ($F = 7.382$, $d.f = 3$, $p < 0.001$). The LSD *post hoc* test revealed a significant difference in the biomass between Camp 4 and 5 ($p < 0.001$); Camps 4 and 7 ($p < 0.01$) and Camps 5 and 6 ($p < 0.01$), Figure 7. Camps 4 and 6 (0.1) and camps 5 and 7 ($p < 0.1$) did not differ significantly in their biomass.

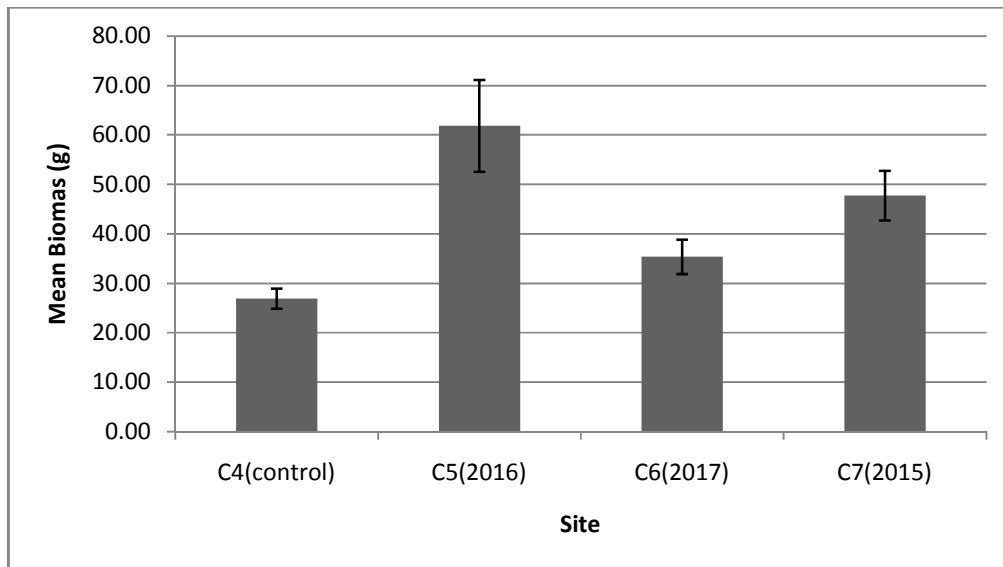

Figure 7: Mean grass biomass of the four experimental camps: C4 (control) = Camp 4 the control, C5 (2016) = Camp 5 chemically treated in 2016, C6 (2017) = Camp 6 treated in 2017, and C7 (2015) = Camp 7 treated in 2015. The bars extending beyond the bar graphs denote the Standard Error of Means (SEM).

The median percentage covers of the studied camps are presented in Figure 8. There was a significant difference in the percentage cover of the experimental camps ($d.f=3$, $H=8.5$, $p < 0.05$). The percentage median cover in Camp 4 was significantly higher than the

median cover in camp 5 ($p < 0.01$) and the median cover in Camp 5 was significantly lower than median cover in Camp 6 ($p < 0.05$).

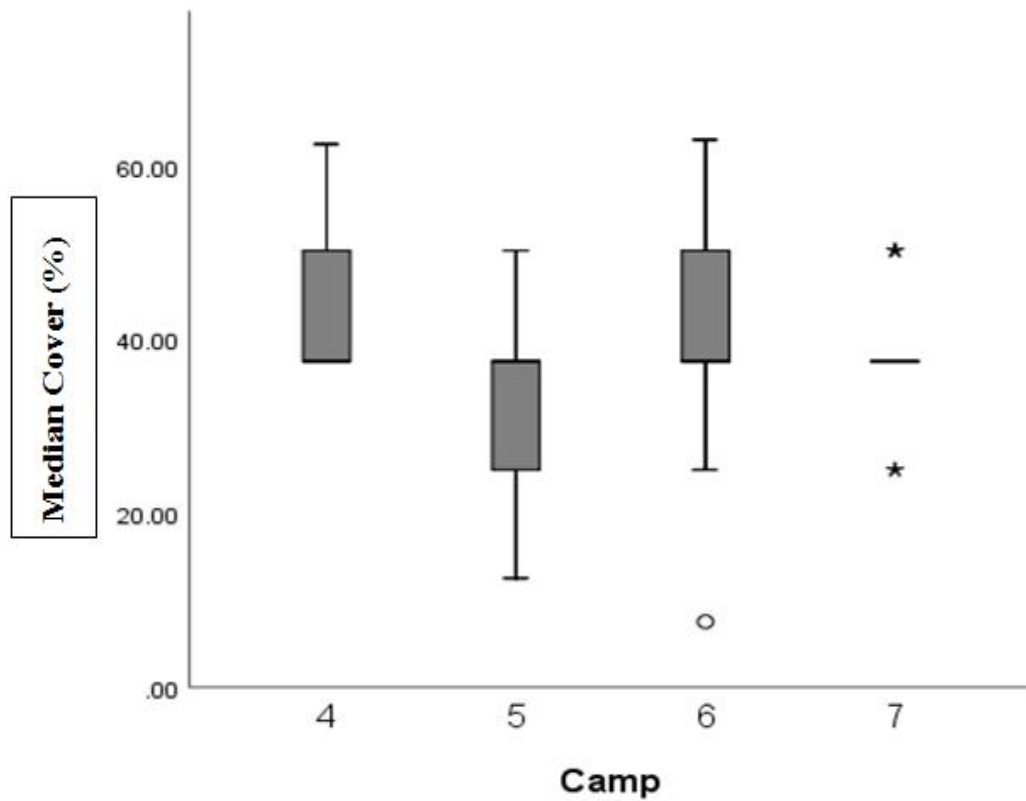

Figure 8: Median percentage cover of herbaceous plants of the four experimental camps. Camp4 control, Camp 5 chemically treated in 2016, Camp 6 treated in 2017, and Camp 7 treated in 2015.

4.1.4 Rangeland condition

There was no significant difference between the observed and expected frequencies among the four camps (Chi-square test, $\chi^2= 7.667$, d. f = 6 and $p=0.264$); (Figure 9).

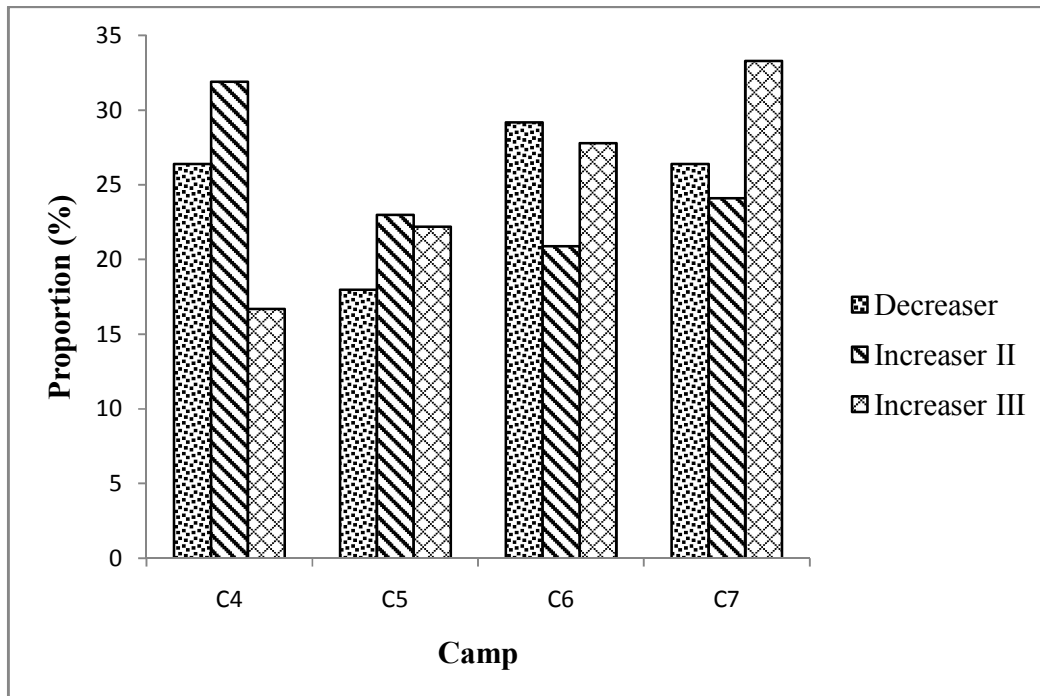

Figure 9: The functional groups of the different grass species found in the camps. C4 (control) = camp 4 untreated, C5 (2016) = camp 5 chemically treated in 2016, C6 (2017) =camp 6 treated in 2017, and C7 (2015) = camp 7 treated in 2015.

The frequency of occurrence of high, average and low grazing value grasses did not significantly differ among the camps (Chi-square test, $\chi^2= 3.495$, d f = 6 and $p=0.745$); Figure 10).

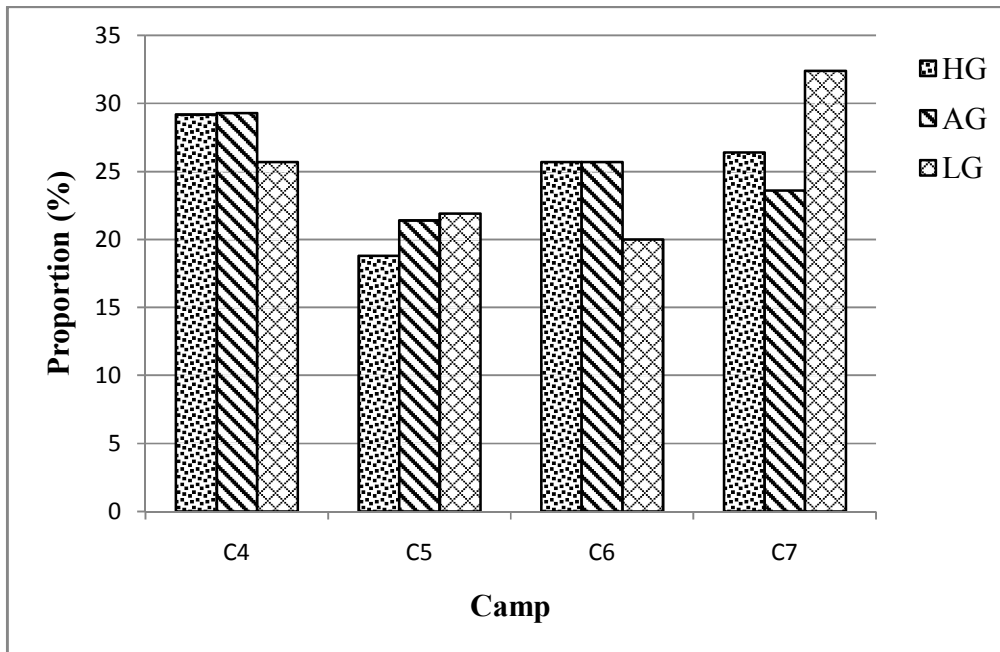

Figure 10: The grazing values of the different species found in the study sites within the camps and across the camps using chi- square values. The HG denotes- High Grazing value; AG- Average Grazing value and LG- Low Grazing value.

4.1.5 Gradients in herbaceous species data

The Detrended Correspondence Analysis (DCA) separated the plots into three main groups along the DCA axes 1 and 2 (Figure 11).

Group 1

Group 1 was mainly associated with plots of Camp 5. Plots associated with this group were from a camp chemically de- bushed in 2016.

Group 2

Group 2 was mainly associated with plots of Camp 7. Plots associated with this group were from a camp which was chemically de- bushed in 2015.

Group 3

This group was associated with a mixture of plots from all the treatment sites and the control.

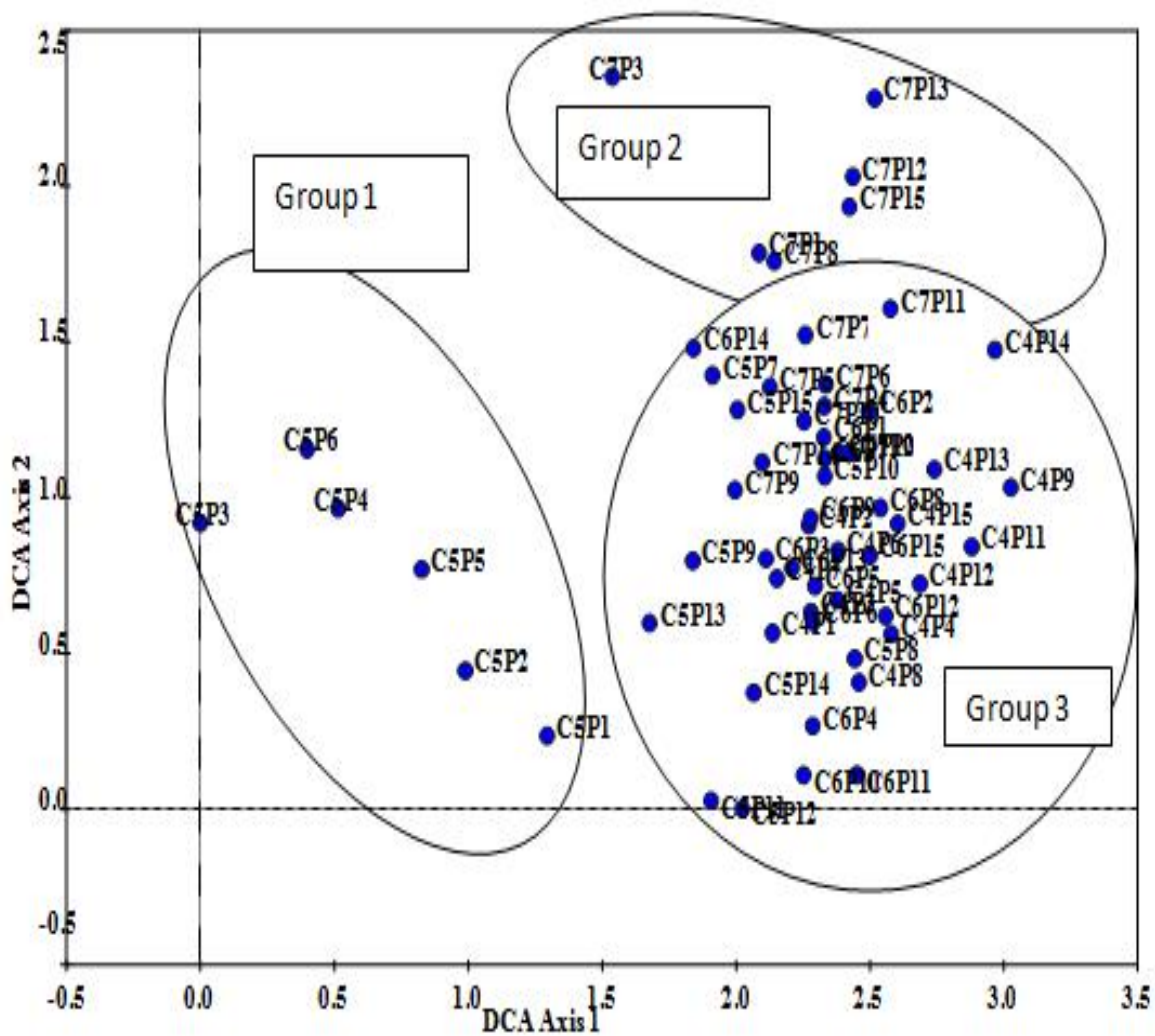

Figure 11: Detrended Correspondence Analysis (DCA) ordination diagram of the herbaceous species recorded from the four experimental sites (C4, C5, C6 and C7). The C4P1 stands for (Camp 4 Plot 1), ...C5P1 (Camp 5 Plot 1),...C6P1 (Camp 6 Plot 1),...C7P1 (Camp 7 Plot 1).

4.2 Ground-dwelling invertebrates

4.2.1 Relative abundance of invertebrates

Table 1 below shows that most invertebrates were collected from camp 4 (control) and the least was recorded in camp 7 which was chemically treated in 2015. Figure 12 shows the most dominant families of invertebrates as they were collected in the four camps. Formicidae was the most dominant family in the experiment, followed by the Aphididae and Cicadellidae.

Table 1: Summary of relative abundance of the invertebrates collected from the experimental camps.

Site	No. of			
	orders	No. of Families	No. of invertebrates	Proportion %
Camp				
4(control)	11	19	832	40.43
Camp 5(2016)	8	15	563	27.36
Camp 6(2017)	6	12	377	18.32
Camp 7(2015)	11	15	286	13.9
Total	36	61	2058	100

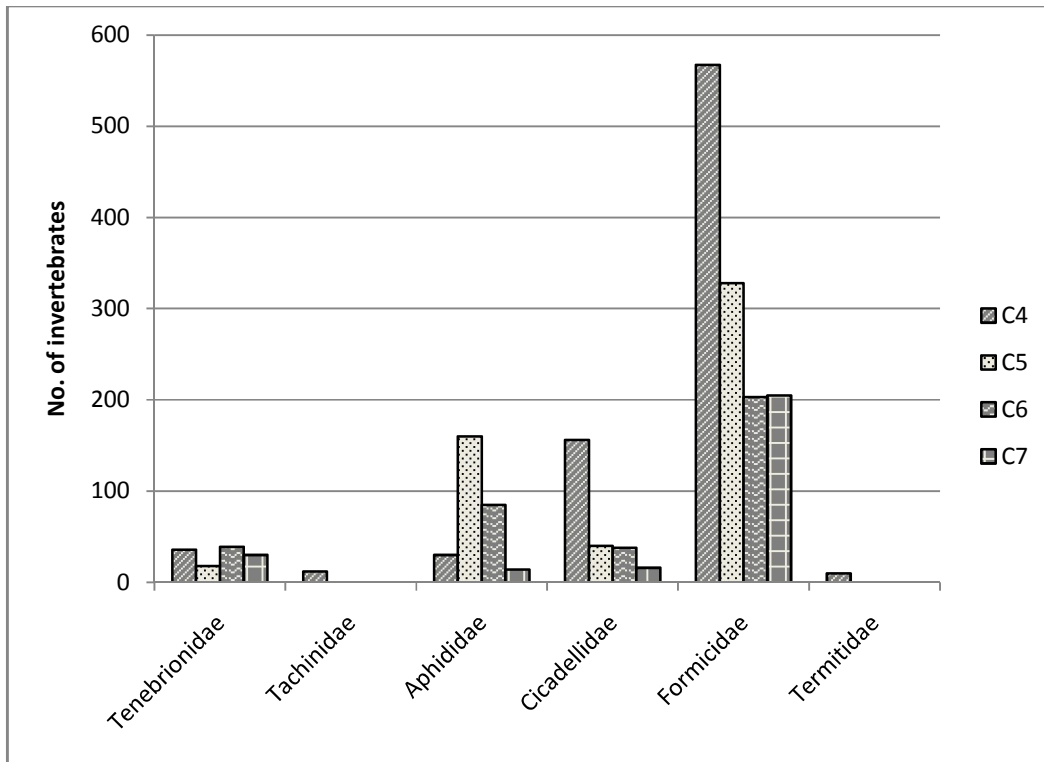

Figure 12: Total abundance of ground- dwelling invertebrates per Family among the four camps. C4 = Camp 4, C5 = Camp 5, C6 = Camp 6 and C7 = Camp 7.

4.2.2 Invertebrate diversity and richness

There was no significant difference in the median invertebrate diversity among the four camps ($H=2.497$, $d.f=3$, $p=0.476$; Figure 13).

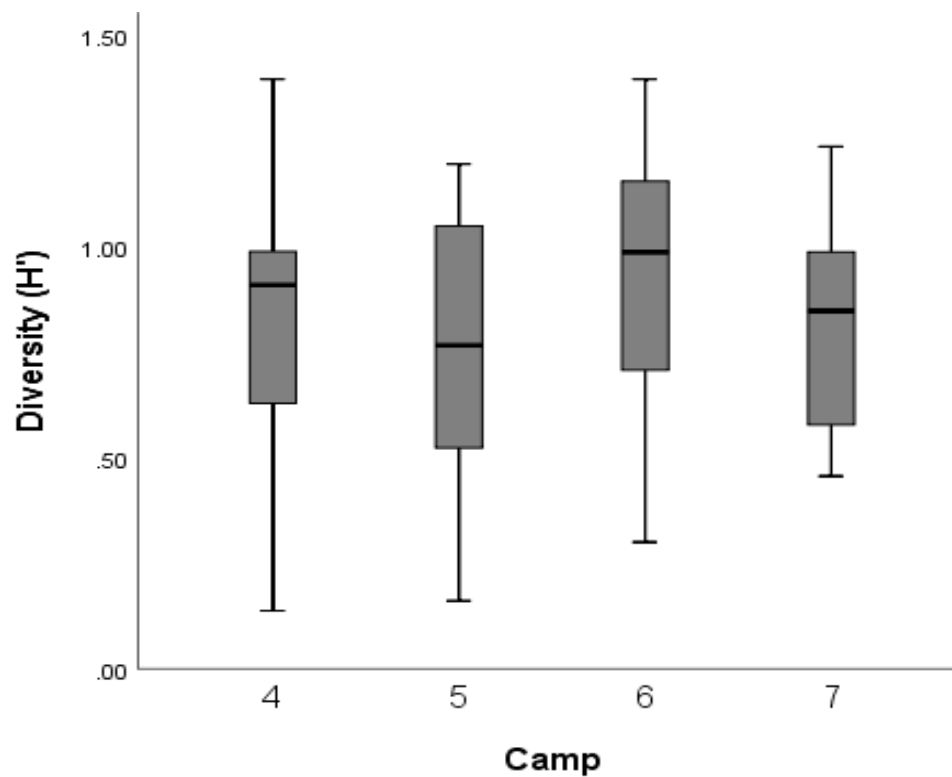

Figure 13: Median ground-dwelling invertebrate diversity among the four camps. Camp 4 Control, Camp 5 chemically treated in 2016, Camp 6 treated in 2017, and Camp 7 treated in 2015.

There was also no significant difference in the Family richness among the camps ($H=0.285$, $d.f=3$, $p=0.963$); Figure 14.

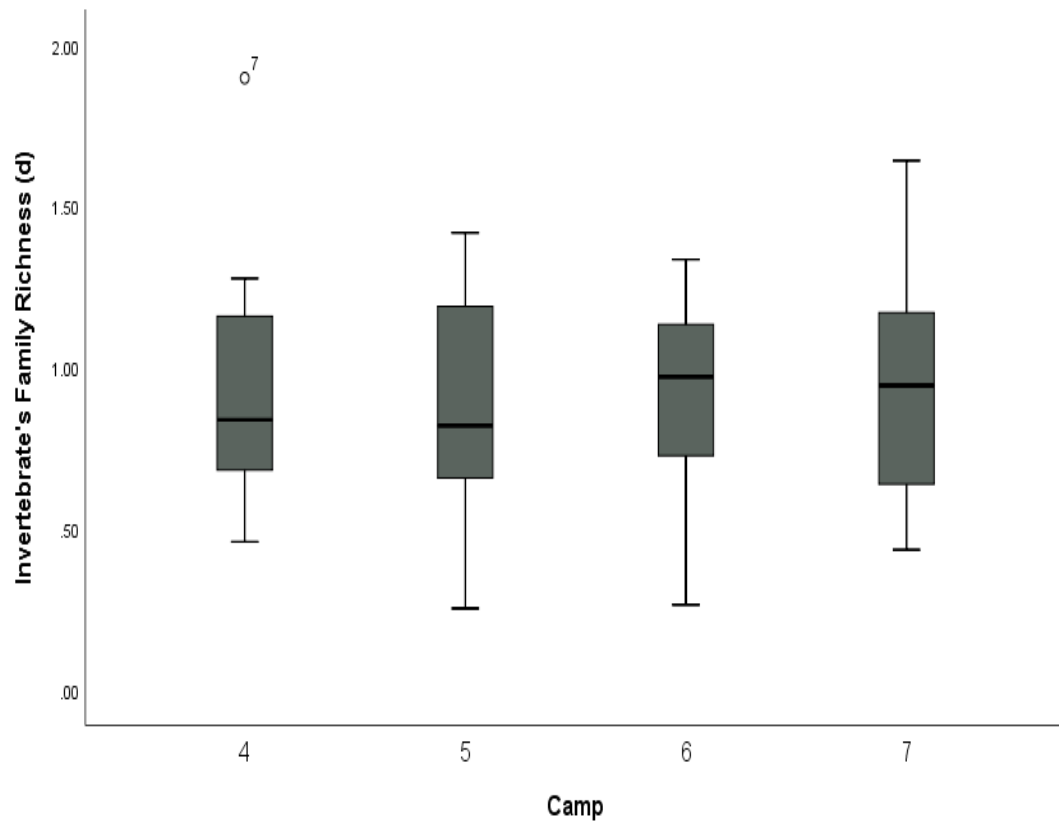

Figure 14: Median ground-dwelling invertebrate richness in the four experimental camps. Camp 4 control, Camp 5 chemically treated in 2016, Camp 6 treated in 2017, and Camp 7 treated in 2015.

4.2.3 Invertebrate species composition

The HCA dendrogram in Figure 15 separated the pitfall traps from the four camps into 7 main clusters. Cluster 1 which was composed of a pitfall trap from Camp 6 and two pitfall traps from Camp 5 showed a general similarity level of about 64 % from the other clusters. The main family invertebrates which were found in the traps of this cluster were Cicadellidae, Aphididae in large numbers and a few Formicidae.

Cluster 2, formed at 50 % level of similarity and is composed of pitfall traps from Camp 4 only, with higher numbers of Cicadellidae and moderate numbers of Formicidae.

Clusters 3 and 4 had a mixture of pitfall traps from all the four camps and were separated at about 52 and 58 % level of similarity, respectively. These clusters recorded higher numbers of Formicidae, few Tenebrionidae and Cicadellidae. A few of the Muscidae were also trapped in cluster 4.

Cluster 5 was dominated by traps from Camp 6. This cluster separated at 50 % level of similarity from other clusters and moderate numbers of Formicidae and a few Tenebrionidae and Cicadellidae were captured from the traps in this camp.

At 58 % level of similarity cluster 6 was formed and consisted of only three traps. This cluster had very few overall invertebrates in the traps.

Cluster 7 had a huge number of traps from all the camps except Camp 5. This cluster was, however, dominated by traps from camp 7. This cluster had fair numbers of Formicidae and few of the Tenebrionidae and Cicadellidae.

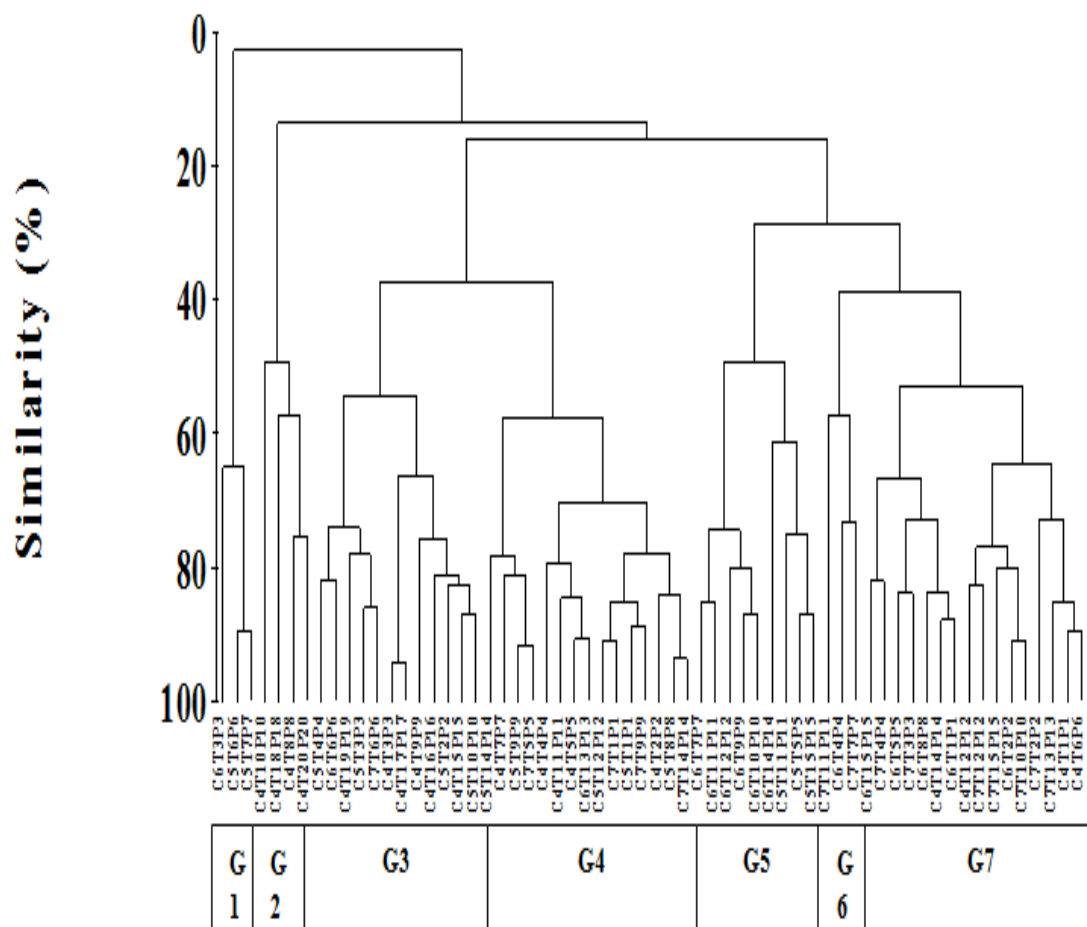

Figure 15: Hierarchical Cluster Analysis (HCA) dendrogram showing differences in invertebrate family composition among the experimental sites, C4T1P1 (Camp 4 Pitfall traps 1),...C5T1P1 (Camp 5 Pitfall trap 1),...C6T1P1 (Camp 6 Pitfall trap 1),...C7T1P1 (Camp 7 Pitfall trap 1). The G1....G7, represents the group of traps forming clusters. Camp4 (control) was not treated, Camp5 was chemically treated in 2016, Camp6 was chemically treated in 2017 and Camp7 was chemically treated in 2015.

4.2.4 Gradients in invertebrates data

The Detrended Correspondence Analysis (DCA) separated the plots into four main groups along DCA axes 1 and 2 (Figure 16).

Group 1

Group 1 did not show a clear grouping of the traps, it consisted of traps from all the camps.

Group 2

Group 2 was more associated with traps from Camp 5 and 6 with an exception of only one trap from the control site. This group was also associated with cluster 5 on the HCA.

Group 3

This group was associated with cluster 1 on HCA and it contained only three traps in total.

Group 4

This group was associated with clusters 2 and 6 on the HCA. It consisted of traps from Camp 4 and 6, although there was atleast one trap each from Camp 5 and 7.

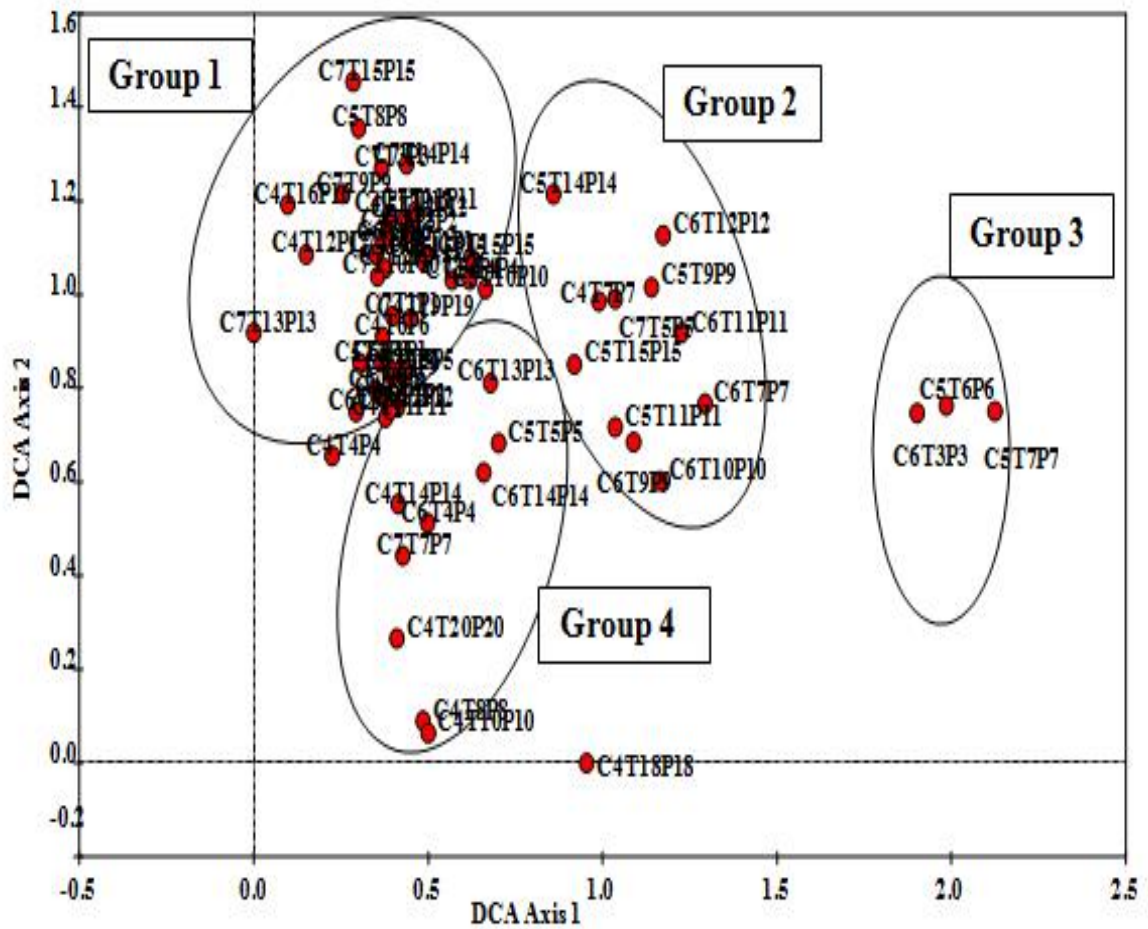

Figure 16: Detrended Correspondence Analysis (DCA) ordination diagram of the invertebrate's families recorded from the pitfall traps that were trapped under the fifteen sampled trees in the four experimental sites (camp 4, camp 5, camp 6 and camp 7). The C4T1P1 stands for (Camp 4 Pitfall trap 1) ...C5T1P1 (Camp 5 Pitfall trap 1),...C6T1P1 (Camp 6 Pitfall trap 1),....C7T1P1 (Camp 7 Pitfall trap 1).

CHAPTER 5

5. Discussion

5.1 Herbaceous diversity, richness and composition

There were 19 grass species dominated by perennials and 21 forb species in the study area. The herbaceous species diversity and richness were significantly different among the camps. The herbaceous species diversity (Figure 4) was higher in the control camp (Camp 4) and lowest in camp 7 which was chemically treated in 2015. This could imply that the diversity declined with the application of the chemicals when de-bushing. The results also showed that the 2016 and 2017 treated camps had approximately equal diversity; however, the camp treated in 2015 had the lowest diversity. Due to poor rainfall, the dislocation and penetration of the arboricides active ingredients into the soil was evidently not possible thus most of the herbaceous vegetation was not affected by the applied arboricide. Hence camp 6 had a higher diversity than camp 7. As de-bushing is mainly aimed at improving grasslands, an adequate and timely recovery of the vegetation on each treated camp was the ultimate goal. Camp 7 showed very little recovery from the chemical impact with an implication that chemical effects could have lasted much longer in the soil than desirable. It is however reported that Bromacil and Tebuthiuron are highly persistent chemicals (Rakewich and Bakker, 2017). There could be several reasons why the chemicals persisted longer in the soil. These could be associated with chemical application techniques (incorrect dosage and broadcasting), the personnel (untrained), and possibly rainfall impact. However, the rate of chemical breakdown in the soil is dependent on soil chemistry, temperature, moisture, microbial

population, herbicide properties, and application rate. While in some instances the long persistence of arboricides is important for weed control, in other cases they can result in negative effects (carry over) that causes damage to the subsequent plants (Gillespie et al., 2011). Rothauge (2015) explained that at high doses of chemical that are applied under the target plant; there could be enough residual chemical to kill other plants in the vicinity. Correspondingly, Gillespie et al., (2011) also emphasized that when Bromacil is applied to control brush, the residue may persist to kill or injure sensitive plants longer than 1 year following application. Following two years after de-bushing programme the rangeland is expected to have improved its herbaceous vegetation diversity, richness and composition. However, the diversity in camp 6 also did not show reasonable improvement compared to the control. Thus it could be concluded that chemicals had a negative and residual effect on the herbaceous species diversity.

Herbaceous species richness (figure. 5) was highest in camp 5 (chemically treated in 2016) and lowest in camp 6 chemically treated in 2017. Camps 4 and 7 showed no significant differences in richness between them. Camp 6 was the last to be chemically de-bushed and some of the arboricide granules could be seen under the *Senegalia mellifera* trees. The effect of the chemicals could therefore still be active and thus the plants could still be undergoing the eradication process. The active ingredients of the arboricides are washed into the plant roots by rain water (Rothauge, 2017b). Run-off water could have washed some of the chemical away from the targeted *Senegalia mellifera* and consequently killing the untargeted plants reducing the species richness and diversity of that camp. However, the minimal rainfall received could have also played a role in reducing the efficiency of dissolving the arboricide granules to reach the

targeted plants and thus could affect the untargeted shallow rooted herbaceous plants and the ground dwelling invertebrates. The presence of the forbs that manifest themselves in disturbed areas such as *Tagetes minuta* and invasive species such as *Nidorella resedifolia* were recorded in camp 5 which may have led to the evident increase in its species richness compared to the un-debushed camp and camp 7 which was debushed a year earlier. The disturbance of the veld with these chemicals could have promoted the proliferation of these invasive species. The year 2016 also received better rainfall than 2015, which is an indication that the chemical could have leached underground to their targeted plant roots much faster and paved way for the herbaceous plants. The dead tree logs were, however, still standing.

Species composition is regarded as an important indicator of ecological and anthropogenic processes at a site (Global Rangelands, 2019). Plots with similar composition were clustered together by the HCA representing the heterogeneity in the herbaceous vegetation communities in the camps. Camp 7 plots did not form association with the plots from other camps, which means that the species composition of this camp was significantly different from the other camps. Apart from the slight association in composition among the other three camps, the camps also demonstrated different species composition among them. Consequently, the impacts of the arboricides, particularly in camp 7, could have been more intense hence the significant changes in vegetation (composition, diversity, richness) due to the prolonged persistence of the chemicals in the soils in the camp (since 2015). The different species composition of the control camp relative to the other camps could have been due to bush encroachment. The DCA did not fully corroborate the output of the dendrogram. However, Clusters 5 and 6 corresponded

with groups 1 and 2 respectively, on the DCA ordination results. Group 3 on the DCA ordination did not show clear gradients and it incorporated the remaining clusters.

5.2 Herbaceous biomass and cover

Following chemical de-bushing the grass biomass was expected to be significantly lower in the un-debushed camp where the grasses could have been out-competed by trees. Typically camp 5 recorded the highest grass biomass, while camp 6 recorded the lowest for the same reasons discussed under the species richness above. The evident persistent and probable actions of the arboricides in camp 6 could be the cause for the site to have lower grass cover. Due to poor rainfalls and from the visible granules of the arboricides under targeted trees in camp 6, the arboricide could be targeting more of the shallow rooted vegetation (herbaceous) than the deep rooted (trees). However, original plant cover variations before tree control cannot be ruled out. On the contrary, camp 7 was expected to record the highest grass biomass, given that it was de-bushed much earlier than the other camps, hence recovered. Although the study did not take into consideration the stages or the patterns of the veld condition throughout the de-bushing process of the treated trees, it could be concluded that the arboricides had, to a certain extent, a negative effect on the grass biomass production. The seedlings of most of the plants are the most susceptible to toxicity and many annual forbs exhibit the process of selection for arboricide resistance under arboricide exposure (Mahmood et al., 2014). Arboricides are said not to kill bush seeds and they germinate rapidly when rainfall is favorable (Rothauge, 2017b). There is, however, no literature that confirms that herbaceous seeds cannot be destroyed by arboricides too.

The statistical test revealed a significant difference in the percentage cover among the four sites. Although not necessarily higher than the woody plant cover, the herbaceous ground cover in the control camp was higher than in the other camps. It could be perceived that due to the high level of persistence of Bromacil and its low degradability in the environment (Lemus and Gordon, 2018), there was constant albeit slow removal of the herbaceous plants in the chemically treated camps, hence the lower herbaceous ground cover in comparison with the encroached untreated site. Despite the record of higher species richness and biomass camp 5 had the lowest ground cover. The higher grass cover observed in camp 6 could be due to fact that the arboricide granules could still be seen under the trees, therefore, dictating that the granules were not yet dislocated thus less active and harmless to even the untargeted vegetation which could have been eliminated in the other treated camps. Consequently it shows that camp 6 had a higher grass cover before tree control.

5.3 Rangeland condition and grazing values of grasses

The major causes of poor rangeland conditions are the use of management practices that do not make provision for adequate recovery of perennial grasses (MAWF, 2012). The study sought to also assess the impact of arboricides applied as a means of managing bush encroachment on Neudamm rangeland condition and the grazing values of grasses.

In most instances the rangeland condition deteriorates because adaptive management is not applied (DAS, 2017) but disturbances such as overgrazing, fire, trampling and other stresses tend to bring about similar consequences. Such other stresses could include the effects of arboricides on the grasses and other plants. The trend of occurrences of the grasses according to their functional groups was statistically not affected by the

arboricides (Figure 9). The only Increaser III grass species (*Aristida meridionalis*) which increased despite the persistence of arboricides was mostly recorded in camp 7 and less so in the control camp. However, most of the grasses recorded in all the camps also grow in disturbed, eroded and poor soil areas (van Oudtshoorn, 2012), with an exception of *Antheophora pubescens* and *Schmidtia pappophoroides* which are indicators of good veld condition and are drought resistant grasses. There were few decreaser species that were recorded; *Eragrostis rotifer*, *Cenchrus ciliaris*, *Antheophora pubescens*, *Schmidtia pappophoroides* and *Fingerhuthia africana*. Camp 7 recorded a higher number in Increaser III. The majority of the 21 forbs recorded in the study also grow in disturbed areas, which is a clear indication that the area is disturbed. A few of the forbs such as *Acrotome fleckii*, *Nelsia quadrangula* and *Pavonia burchelli* were found in the shade of trees. Most of these forbs were recorded in camps 4 and 6. One can infer that a chemically de-bushed area declines in rangeland condition before it improves. Rangelands in poor condition need three to four times more water to produce the same amount of grass compared with rangelands that are in an optimal condition (DAS, 2016).

Forage material should provide the animals with good nutrition and other benefits that can lead to a more productive growth of the animal. The grazing value of the grass is highly influenced by production, palatability, nutritional value, growth vigor, digestibility and habitat preference. Based on these factors the grasses are categorized as being grasses of low (LG), average (AG) or high (HG) grazing value (van Oudtshoorn, 2012). The veld in the study camps was dominated by sub-climax species which according to observation, they manifested themselves after the treatment. This was an

indication that most of the vegetation began to recover towards its original state from the chemical disturbances.

5.4 Invertebrate species abundance

The effect of de-bushing on the ground dwelling invertebrates is dependent on the severity of the disturbances (Perry and Herms, 2019). Oxbrough et al., (2010) emphasized the importance of invertebrates as decomposers, pollinators, herbivores, predators and prey. A total of 2058 invertebrates were trapped in this study, of which camp 4 (control) recorded the highest proportion (40.4 %) and camp 7 (treated 3 years ago) recorded the lowest proportion (13.9%). Eleven orders and 19 Families of invertebrates were recorded in this study. The most abundant family Formicidae was recorded in all the camps but was highest in the control relative to the treated camps. Formicidae has been found to be sensitive to disturbance, hence the lower numbers recorded in the chemically disturbed sites. The family's abundance clearly was lower in the camp treated 3 years ago and this could be due to the fact that the chemical residues might still be persistence in the soil and continued to inhibit the vegetation growth which consequently reduced the number of ground- dwelling invertebrates. While the herbicides/arboricides were intended for the elimination of unwanted plants other living organisms that rely on those plants for nutrition or habitat can come in contact with the chemicals and be affected (Albanese, 2019).

5.5 Invertebrate species diversity, richness and composition

According to Morkel (2013), high species diversity indicates a complex community in which a high degree of species interactions is possible. Despite the higher relative abundances of invertebrates in camp 4, statistically the family diversity and richness did

not show any significant differences among the camps. The species richness results show a declining pattern though not significant from the untreated site to the site older in chemical treatment. However, a study conducted by Watts et al., (2016), which also fits well with the shown trend, concluded that invertebrates are rather more sensitive to the changes in vegetation canopy. The effect of chemicals could be indirect as the vegetation loses canopy due to the herbicides/arboricides treatments. Similarly, a study on the negligible effects of the herbicides/arboricides on ants and springtails on an Australian wheat field demonstrated that there is minimal effect of herbicides or arboricides on most species of surface-active arthropods (Greendale et al., 2010). All the sites did not have much complexity in their invertebrate communities. Lack of significance of the family diversity and richness could have been due to the low evenness in some camps, whereby Formicidae, Cicadellidae and Aphididae were highly dominant out of the 19 recorded families. The diversity, richness and composition of the invertebrates were analyzed at family level (coarse taxonomic scale) instead of species level due to lack of expertise in the field of insect taxonomy thus the results were not well refined.

The HCA showed significant differences in invertebrate family composition. The group of clusters G7 had a unique composition that is composed of pitfall traps from camp 7 and dominated by the Formicidae, Tenebrionidae and Cicadellidae families. Despite the fact that the invertebrates family richness and diversity did not differ the camps differed in some of their composition. The control camp showed more heterogeneity in species composition as its canopy cover was not affected by arboricides (no treatment). According to the DCA diagram (Figure 16), the control traps did not show a clear

grouping on the x-axis indicating that there is no dominant influence on the DCA gradient. The elimination of the trees by the use of chemicals generated dynamic temporal and spatial patterns of canopy gap formation consequently causing the ground-dwelling invertebrates to be dynamic as well, as they depend on the properties of the chemical disturbance (Perry and Herms, 2019).

CHAPTER 6

6. CONCLUSIONS AND RECOMMENDATIONS

6.1 Conclusions

- (a) Herbaceous species diversity and richness declined with the application of the chemical. The phytotoxic residues of Bromacil in camp 7 persisted in soils for longer than 2 years, showing the long residual effects of the chemical. Thus the hypothesis that de-bushing rangelands with chemicals has no significant effect on the herbaceous diversity and richness is rejected. It is concluded that chemical de-bushing has a significant negative effect on the herbaceous species diversity.
- (b) There were significant changes in the species composition in the treated sites compared to the control. The change in the composition was due to the chemical effect and camp 7 showed that it might have longer chemical persistence in the soil. It can therefore be concluded that de-bushing rangelands with chemicals has a significant negative effect on herbaceous species composition.
- (c) The grass biomass of the treated camps was significantly higher than the grass biomass of the untreated camp. The mortality of the trees in the treated camps gave space to the herbaceous plants and the proliferation of the species that grow better in disturbed areas such as *Aristida meridionalis*, among others. The study rejects the null-hypothesis and concludes that de-bushing of the rangelands with arboricides results in increases in grass biomass.
- (d) The control camp had higher ground cover than the treated sites, the higher the woody cover the lower the grass cover. The cover in the control was higher

because the grass cover in the treated sites was affected by the arboricides. The null- hypothesis that there is no significant difference in grass cover among sites is rejected. It is concluded that de-bushing rangelands with arboricides reduces grass cover.

- (e) Proportions of grasses in the various grazing value categories did not differ significantly among camps. All the camps were characterized mostly by average grazing value grasses and a few high grazing value grasses. It is therefore concluded that de-bushing rangelands with arboricides does not have a significant effect on the grazing value of the rangelands.
- (f) Rangeland condition did not differ significantly and the ecological status of the camps was similar. The null- hypothesis is therefore retained and concludes that de-bushing rangelands with arboricides does not have a significant effect on rangeland condition based on functional groups of grasses.
- (g) Ground-dwelling invertebrate Family diversity did not differ significantly among camps. This is largely attributed to the coarse level (Family) of analysis and low evenness. Therefore the null hypothesis is rejected and concludes that de-bushing rangelands with arboricides does not have a significant effect on the Family diversity of the ground- dwelling invertebrates.
- (h) The Family richness of the ground-dwelling invertebrates did not differ significantly among camps because any losses due to chemical effects could have been compensated by tolerant species (since Family composition was different). Therefore the study retained the null- hypothesis and concludes that de-bushing the rangelands with arboricides does not have significant effect on the Family richness of ground-dwelling invertebrates.

- (i) There were significant changes in the ground-dwelling Family composition in treated camps compared to the control site due to the effects of the chemical, among other reasons. The null hypothesis is therefore rejected and concludes that de-bushing rangelands with chemicals has significant negative effect on ground dwelling invertebrate Family composition.

6.2 Recommendations

- (a) The objectives of this study were to investigate the effects of arboricides on the herbaceous plant communities and the ground-dwelling invertebrates. It is recommended that further investigation be done to eliminate other underlying factors (confounding factors) for better understanding of the effects.
- (b) It is also recommended that by the continuation of the usage of the arboricides, broadcasting should be carried out with care, in right quantities to reduce the effects of long persistence of the chemicals in the soils because they tend to have long term effects on the vegetation which subsequently have an effect on the ground-dwelling invertebrates.
- (c) Soil analysis should be done to determine the amounts of the chemical residues in the soils and the exact persistence of such residues in the soil over time.
- (d) It is recommended that a study covering all seasons should be carried out to determine the temporal variations in invertebrates and herbaceous species. Some invertebrate species might go into hibernation in colder seasons or vice versa. And some herbaceous plant may be frost intolerant. Hence the results may not be reflective of the real situation.
- (e) It is also recommended that the invertebrate analysis be done at species level rather than at family level, hence all the invertebrates should be accurately identified at species level.

References

- Acero, J. 2017. Bromacil- toxicity, side effects, diseases and environmental impacts. Naturalpedia. Retrieved on 17/08/2018 from <https://naturalpedia.com/bromacil-toxicity-side-effects-diseases-and-environmental-impacts.html>.
- Aggemyr, E., A. G. Auffret, J. Love, and S. A. O. Cousins. 2018. Species richness and composition differ in response to landscape and biogeography Springerlink. *Landscape Ecology*, 33(12), 2278–2284. <https://doi.org/https://doi.org/10.1007/s10980-018-0742-9>.
- Aktar, M. W., D. Senguta, A. Chowdhury. 2009. Impact of pesticides use in agriculture: their benefits and hazards. *Interdiscip Toxicol*. 2(1): 1- 12. doi:10.2478/v10102-009-0001-7.
- Albanese, D. 2019. Negative effects of common herbicides on non- target Invertebrates. MSc Thesis. Electronic Theses and Dissertation. <http://digitalcommons.geogiasouthern.edu/etd/1966>.
- Askari Wilderness Conservation Programme. (2010). Bush encroachment & erosion control. Reserve Work. Retrieved on 19/10/2018 from <http://www.askarivolunteers.com/reserve-work/bush-encroachment-erosion-control-read-more-here/>.
- Birch, C., L. Harper-Simmonds, L. Lindeque, and A. Middleton. 2016. An assessment of the economics of land degradation related to bush encroachment in Namibia. Namibia Nature Foundation.

Birch, C. and A. Middleton. 2017. Regional assessment of the economics of land degradation related to bush encroachment in Otjozondjupa region, Namibia. Otjozondjupa ELD final report. Namibia Nature Foundation.

Bond, W. J., and G. F. Midgley. (2012). Carbon dioxide and the uneasy interactions of trees and savannah grasses. *Phil. Trans. R. Soc. B* 2012 367, 601- 612. doi: 10.1098/rstb. 2011. 0182.

Bunning, S., J. McDonagh, and J. Rioux. 2011. Vegetation assessment. Manual for local level assessment of land degradation and sustainable land management, Part 2, 39–66. Retrieved on 16/09/2018 from http://www.fao.org/fileadmin/templates/nr/kagera/Documents/LADA_manuals/part2_c.pdf.

Bush Encroachment and Forestry- South Africa. 2010. Bush Encroachment Control Methods.

Christian, C. 2010. Environmental impact assessment report, energy for future: Bush- to - fuel Project. Environmental impact assessment report, Colin Christian & Associates, Windhoek, Namibia.

Coetzee, M. E. 2009. Chemical characterization of the soils of East- Central Namibia. Thesis (MSc). University of Stellenbosch, South Africa.

DAS. 2016. What techniques or methods can I use for harvesting bush. Retrieved on 26/06/2018 from http://www.dasnamibia.org/hrf_faq/what-techniques-or-methods-are-available-to-harvest-encroacher-bush/.

- DAS. 2017. Control of encroacher bush species in Namibia. Retrieved on 26/06/2018 from <http://www.dasnamibia.org/download/brochures/Bush-Control-Methods-Poster-03.pdf>.
- Devine, A. P., R. A. McDonald, T. Quaiife, and I. M. D. Maclean. 2017. Determinants of woody encroachment and cover in African savannas. *Oecologia* 183 (4). p. 939-951. <https://doi.org/10.1007/s00442-017-3807-6>.
- Ding, J., S. K. Tavers, M. Delgado- Baquerizo, and D. J. Eldridge. 2019. Multiple trade-offs regulate the effects of woody plant removal on biodiversity and ecosystem functions in global rangelands. *Global Change Biology*, 26 (2), p. 709- 720. doi: 10.1111/gcb.14839.
- Gandiwa, E. 2011. Effects of repeated burning on woody vegetation structure and composition in a semi-arid southern African savanna. *International Journal of Environmental Sciences*, 2(2), 458–471. <https://doi.org/10.6088/ijes.00202020009>.
- Garcia-Dominguez, C., J. R. Arevalo, and L. Calvo. 2010. Short- term effects of low-intensity prescribed fire on ground- dwelling invertebrates in a Canarian pine forest. *Forest Systems*, 19 (1), 112- 120. ISSN: 2171- 5068.
- Gillespie, W. E., G. F. Czapar, and A. G. Hager. 2011. A pesticide fate in the environment: A guide for field inspectors. Champaign, Illinois.
- Greendale, P. J. M., I. A. Reid, I. Packer. 2010. Herbicides have negligible effects on ants and springtails in an Australian wheat field. *Soil Biology and Biochemistry* 42: 1172- 1175 doi.org/10.1016/j.soilbio.2010.03.009

- Gschwender, F. 2018. Bush control and biomass utilization (BCBU), GIZ Namibia.
- Haddad, C. R., S. H. Foord, R. Fourie, and A. S. Dippenaar- Schoeman. 2015. Effect of a fast- burning spring fire on the ground- dwelling spider assemblages (Arachnida: Araneae) in a central South African grassland habitat. *African Zoology*, 50 (4), 281-292. <https://doi.org/10.1080/15627020.2015.1088400>.
- Hausmann, N. S., J. M. Kalwij, and S. Bezuidenhout. 2015. Some ecological side-effects of chemical and physical bush clearing in a Southern African rangeland ecosystem - ScienceDirect. *South African Journal of Botany*, 102, 234- 239. <https://doi.org/10.1016/j.sabj.2015.07.012>.
- Hering, R., M. Hauptfleisch, K. GeiBler, A. Marquart, M. Schoenen and N. Blaum. 2018. Shrub encroachment is not always a land degradation: Insights from Ground-dwelling beetle species niches along a shrub cover gradient in a semi- arid Namibian savanna. *Land Degradation and Development*, 30(1), p. 14- 24. <http://doi.org/10.1002/ldr.3197>.
- Honsbein, D. 2012. Evaluation of studies previously conducted on possible environmental effects of the generic arboricides tebuthiuron and bromacil the applicability of results of such studies to Namibian conditions and recommendations for future research. A desktop study conducted on behalf of the Meat Board of Namibia.
- Honsbein, D., and C. Lindeque. 2017. Bush encroachment -turning a problem into an industry. Economic Association of Namibia. Retrieved on 22/06/2018 from <https://www.ean.org.na/wp-content/uploads/2017/04/N-BiG-Biomass-Industry->

Article-final.pdf.

Joubert, D., and I. Zimmermann. 2017. Decision support system on how to control bush thickening by *Acacia mellifera* in Namibian savanna rangelands. GIZ- Debushing-DSS- Booklet-2017.

Kahumba, A. 2010. Comparison of the rehabilitation effects of mechanical and chemical methods of bush control on degraded highland savanna rangelands in Namibia. MSc. Thesis. University of Namibia, Windhoek, Namibia.

Kandiwa, E., O. Madzingira, B. Mushonga, A. Samkange, A. S. Bishi and N. F. Nyoni. 2017. A 13 year retrospective study of the beef and dairy cattle losses at Neudamm farm in the Khomas Region of Namibia. *Alexandria Journal of Veterinary Sciences*, Vol. 55 (1): 8- 20. doi: 10.5455/ajvs.270379.

Kent, M. 2012. *Vegetation description and data analysis. A practical approach.* 2nd Edition, John Wiley & Sons, Chichester.

Kgosikoma, O. E., B. A. Harvie, W. Mojeremane. 2012b. Bush encroachment in relation to rangeland management systems and environmental conditions in Kalahari ecosystem of Botswana. *African Journal of Agricultural Research* 7: 2312- 2319.

Kgosikoma, O. E., and K . Mogotsi. 2013. Understanding the causes of bush encroachment in Africa : The key to effective management of savanna grasslands. *Tropical Grasslands- Forrajes Tropicales* 1 (2) 215- 219.

Lemus, R and J. Gordon. 2018. Prescribed burning for pasture management. Mississippi State University, Extension. Agricultural Communications.

<https://extension.msstate.edu/sites/default/files/publications/publications/p2726.pdf>

- Lesoli, M. S., M. Gxasheka, T. B. Solomon, and B. Moyo. 2013. Integrated plant invasion and bush encroachment management on Southern African rangelands. In: A. J. Price and J. Kelton, *Herbicides: Current Research and Case studies in use*, Chapter 11. Intech. p. 259- 313.
- Mahmood, Q., B. Muhammad, and J. Sumira. 2014. Chapter 17 - Herbicides, pesticides, and plant tolerance: An Overview. *Emerging technologies and management of crop stress tolerance*, 1st edition. In: P. Ahmad and S. Rasool. *A sustainable approach* Vol. 2. Academic Press. p. 423-448.
- <https://doi.org/10.1016/B978-0-12-800876-8.00017-5>.
- MAWF. 2012. National rangeland management policy and strategy restoring Namibia's rangelands. Ministry of Agriculture, Water and Forestry, Government of the Republic of Namibia.
- Mendelsohn, J., A. Jarvis , C. Roberts, and T. Robertson. 2009. *Atlas Namibia: A potrait of the land and its people*. 3rd ed. Sunbird Publishers. Cape Town, South Africa
- MET. 2013. Namibia ' s second national biodiversity strategy and action plan 2013-2020. Ministry of Environment and Tourism, Government of the Republic Namibia.
- Morkel, M. 2013. Diversity , structure and dynamics of an acacia erioloba woodland in the windhoek area : insights for the management of urban habitats. MSc. Thesis. University of Namibia and Humboldt Universitat zu Berlin.

- O'Connor, T., J. Puttick, and T. Hoffmann. 2014. Bush encroachment in Southern Africa: changes and causes. *African Journal of Range and Forage Science*, 31(2): 67- 88. <https://doi.org/https://doi.org/10.2989/10220119.2014.939996>.
- Oxbrough, A., S. Irwin, T. C. Kelly, and J. O'Halloran. 2010. Ground-dwelling invertebrates in reforested conifer plantations. *Forest Ecology and Management*, 259(10), 2111–2121. <https://doi.org/10.1016/j.foreco.2010.02.023>.
- Perry, K. I., and D. A. Herms. 2019. Dynamic responses of ground- dwelling invertebrate communities to disturbance in forest ecosystems. *Insects* 2019, 10(3). p.61. <https://doi.org/https://doi.org/10.3390/insects10030061>.
- Rakewich, B., and H. Baker. 2017. Those stubborn sterilants- Environmental management of sites impacted with Bromacil, Dicamba and Tebuthiuron in Alberta. Remediation Technologies Symposium. Nicols Environmental (Canada) Ltd.
- Redjadj, A., C. Duparc, K. Lavorel, S. Grigulis, C. Bonenfant, D. Maillard, S. Said and A. Loison. 2012. Estimating herbaceous plant biomass in mountain grasslands : a comparative study using three different methods. *Alp Botany* 122, 57–63. <https://doi.org/10.1007/s00035-012-0100-5>.
- Rothauge, A. 2014. Baseline assessment for the de-bushing programme in Namibia. AgriConsult Namibia.
- Rothauge, A. 2015. Chemical bush control: Soil-applied arboricides. Retrieved on 28/04/2018 from <https://www.namibian.com.na/print.php?id=133714andtype=2>.

- Rothauge, A. 2017a. Bush encroachment in Namibia. GIZ- de- bushing bush control manual. p. 9- 19.
- Rothauge, A. 2017b. Bush control methods. GIZ- de- bushing bush control manual. p. 22- 36.
- SAIEA. 2016. Strategic environmental assessment of large- scale bush thinning and value- addition activities in Namibia- final report. Environmental information service, Namibia.
- Shekuza, D. 2015. De-bushing environ-mental. Retrieved 09/12/2018, from <https://namibgreen.wordpress.com/tag/de-bushing/>.
- Sherley, G., and I. Stringer. 2016. Invertebrates: pitfall trapping. Department of Conservation Te Papa Atawhai. DOCCM- 248862 p. 1–30.
- Shimles, A and G. Muluaem. 2018. A Review of bush encroachment effect on cattle ranging in rangelands. *Journal of Rangeland Science*, Vol. 8, No. 4, 403- 415.
- Snyman, H. A. 2012. Control measures of the encroacher shrub, *Seriphium plumosum*. *South African Journal of Plant and Soil*: vol. 29, No. 3- 4, p. 157- 163, doi/abs/10.1080/02571862.2012.745905.
- Snyman, H. A. 2015. Short-Term responses of Southern African Semi- arid rangelands to fire: A review of impacts on plants, *Arid Land Research and Management*. 29 (2), 237- 254, doi: 10.1080/15324982.2014.960625
- Species Composition Global Rangelands. 2019. Global Rangelands. Retrieved on 12/10/2019. <https://globalrangelands.org/inventorymonitoring/composition>.

van der Merwe, P. 2011. Agricola 2011, Number 21. Ministry of Agriculture and Forestry, Government of the Republic of Namibia.

van Oudtshoorn, F. 2012. Guide to grasses of Southern Africa. Pretoria South Africa: Briza Publications. ISBN 9781920217358/ISBN 978-1-920217-35-8

Watts, C., D. Thornburrow, and V. Cave. 2016. Responses of invertebrates to herbicides in a *Salix cinerea* invaded wetlands: Restoration implications. *Ecological Management and Restoration*, 17, 3 (243-249).

Appendices

Appendix 1:

	Perenniality (P/A)	Grazing value (HG/LG/AG)	Grazing status	Plant succession
C_virgata	A	HG	Increaser II	Pioneer grass
E_echinocloidea	WP	AG	Increaser II	Subclimax*
S_verticillata	A	AG	Increaser II	Pioneer grass
C_ciliaris	P	HG	Decreaser grass	Climax grass
M_repens	WP	LG	Increaser II	Subclimax
A_pubescens	P	HG	Decreaser grass	Pioneer grass
S_ioclados	WP	AG	Increaser II	Subclimax
A_meridionalis	p	LG	Increaser III	Climax grass
P_fleckii	A	LG	Increaser II	Subclimax
E_rotifer	P	AG	Decreaser/Increase r	Subclimax
A_congesta	WP	AG	Increaser II	Subclimax

				*
A_stipitata	WP	LG	Increaser II	Subclimax *
E_nindensis	p	AG	Increaser II	Subclimax
S_pappophoroide s	P	HG	Increaser II, Decreaser	Climax grass *
F_africana	p	AG	Decreaser grass	Climax grass *
H_contortus	P	AG	Increaser II	Subclimax
S_uniplumis	WP	AG	Increaser II	Subclimax
E_superba	WP	AG	Increaser II	Subclimax